



**20  
23**





Dal 1963 ci occupiamo principalmente della **produzione e fornitura di articoli professionali per la collettività**. Con dedizione ed impegno ci siamo evoluti, diventando una realtà consolidata anche nel settore della ristorazione, hotelleria e pizzeria. Il contatto quotidiano con migliaia di acquirenti Italiani ed Esteri, ci ha portato ad analisi continue ed investimenti su nuovi macchinari e tecnologie innovative, di recente è stata spostata nei nostri stabilimenti la produzione di molti articoli, in modo da garantire ai nostri clienti il **massimo livello di flessibilità e personalizzazione** su una vasta gamma di prodotti quali menù, segnaletica, lavagne e contenitori, (visita [www.talk-u.com](http://www.talk-u.com)), oltre ad un magazzino di 4600 m<sup>2</sup> con disponibilità immediata della merce e tempi rapidi di consegna. **Stil Casa Snc è un'azienda dinamica in continua evoluzione**, la qualità di un partner affidabile per la vostra professionalità.

Since 1963 we deal mainly with the **production and supply of professional items for the community**. With dedication and commitment we have evolved, becoming a consolidated reality also in the catering, hotellerie and pizzeria sectors. The daily contact with thousands of Italian and foreign buyers, has led us to continuous analysis and investments on new machinery and innovative technologies, recently the production of many items has been moved to our factories, so as to guarantee our customers the **highest level flexibility and customization** on a wide range of products such as menus, signage, blackboards and containers visit ([www.talk-u.com](http://www.talk-u.com)), as well as a warehouse of 4600 m<sup>3</sup> with immediate availability of goods and fast delivery times. **Stil Casa Snc is a dynamic company in continuous evolution**, the quality of a reliable partner for your professionalism.

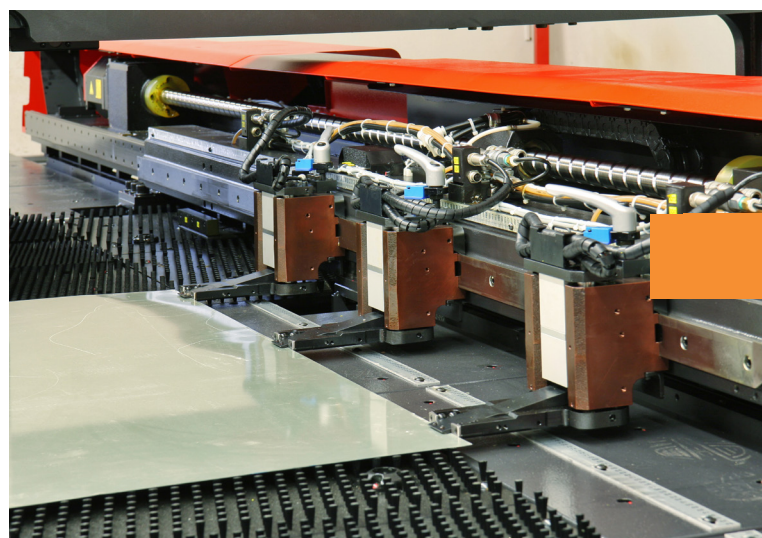

# I N D I C E

index, index

## LINEA PURE

“Pure” line / Ligne “Pure”



### PORTAOMBRELLI

Umbrella stand - Porte parapluie

8

### CONTENITORE DA INTERNO

Indoor wastebin / Poubelle pour intérieur

9

### POSACENERE DA ESTERNO COPERTO

Covered outdoor wastebin with ashtray  
Poubelle avec cendrier pour extérieur couvert

12

### STAZIONI PER RACCOLTA DIFFERENZIATA

Indoor separate waste station bins  
Poubelle tri sélectif pour intérieur

14

### CONTENITORI CON APERTURA FRONTALE

Frontal opening wastebin / Poubelle avec vidage frontal



22

## LINEA ROUND

“Round” line / Ligne “Round”



### CONTENITORI SINGOLI

Single bin - Poubelles singles

29

### CONTENITORI RACCOLTA DIFFERENZIATA - LT 100

Recycling waste bin 100 L - Poubelles pour tri sélectif 100 L

30

### CONTENITORI RACCOLTA DIFFERENZIATA - LT 70

Recycling waste bin 70 L - Poubelles pour tri sélectif 70 L

32

### CONTENITORI RACCOLTA DIFFERENZIATA - LT 50

Recycling waste bin 50 L - Poubelles pour tri sélectif 50 L

36

## LINEA GASTRO

“Gastro” line / Ligne “Gastro”



### CONTENITORI DA 110, 90 E 70 LITRI

110, 90 and 70 liters - Poubelles 110, 90 et 70 litres

42

### REGGISACCO

Bag holder - Poubelles porte sac

44

## LINEA REWASTE

“Rewaste” line / Ligne “Rewaste”



### CONTENITORI IN CARTONE 60 E 100 LT

Carton bins 60 and 100 liters / Poubelles en carton 60 et 100 litres

47

### CONTENITORE PORTA BICCHIERI IN CARTONE 60 E 100 LT

Carton bins 60 and 100 liters for glasses  
Poubelles en carton 60 et 100 litres pour verres en plastique

48

# I N D I C E

index, index

## LINEA MODULA Outdoor

“MODULA Outdoor” line / Ligne “MODULA Outdoor”



### CONTENITORI CON SECCHIO

Wastebins with plastic bucket / Poubelles avec seau en plastique



52

### CONTENITORI REGGISACCO

Bag holder wastebins / Poubelles supporte sac



54

### POSACENERE DA TERRA E MURALE

Ground fixing and wall fixing ashtray / Cendrier mural et avec fixation au sol

56

## LINEA STANDARD

“STANDARD” line / Ligne “STANDARD”



### PORTAOMBRELLI

Umbrella stand / Porte parapluie

64

### GETTACARTA DA INTERNO

Indoor wastebin / Poubelle pour intérieur

65

### GETTACARTA AUTOESTINGUENTE

Self-extinguish bin / Poubelle autoextinguible

66

### GETTACARTA AUTOESTINGUENTE CON POSACENERE

Self-extinguish bin with ashtray / Poubelle autoextinguible avec cendrier

68

### PATTUMIERE A PEDALE

Pedal bins / Poubelles à pedale

70

## LINEA TALK

“TALK” line / Ligne “TALK”



### SOTTOPIATTI E RUNNER

Placemat and runner / Set de table et runners



78

### VASSOI DA PORTATA

Service trays / Plateaux de service

83

### PORTA MENU E ACCESSORI

Menu holders and accessories / Porte menus et accessoires

84; 98

### VASSOI PER CAMERA HOTEL

Hotel's room trays / Plateaux pour chambre d'hotel



92

### ACCESSORI PER CAMERA HOTEL

Hotel's room accessories / Accessoires pour chambre d'hotel

96

### PERSONALIZZAZIONI

Customizations / Personnalisations

102

### PITTOGRAMMI IN PVC

PVC pictograms / Pictogrammes en PVC

106

## LINEA HOTEL

“Hotel” line / Ligne “Hotel”



### COLONNE DIVIDI FOLLA CON NASTRO E DISPLAY

Crowd barrier with tape and display / Poteaux avec bande et display

109

### COLONNE CON CORDONE, DISPLAY E LEGGIO

Crowd barrier with rope, display and stand / Poteaux avec corde, display et pupitre

111

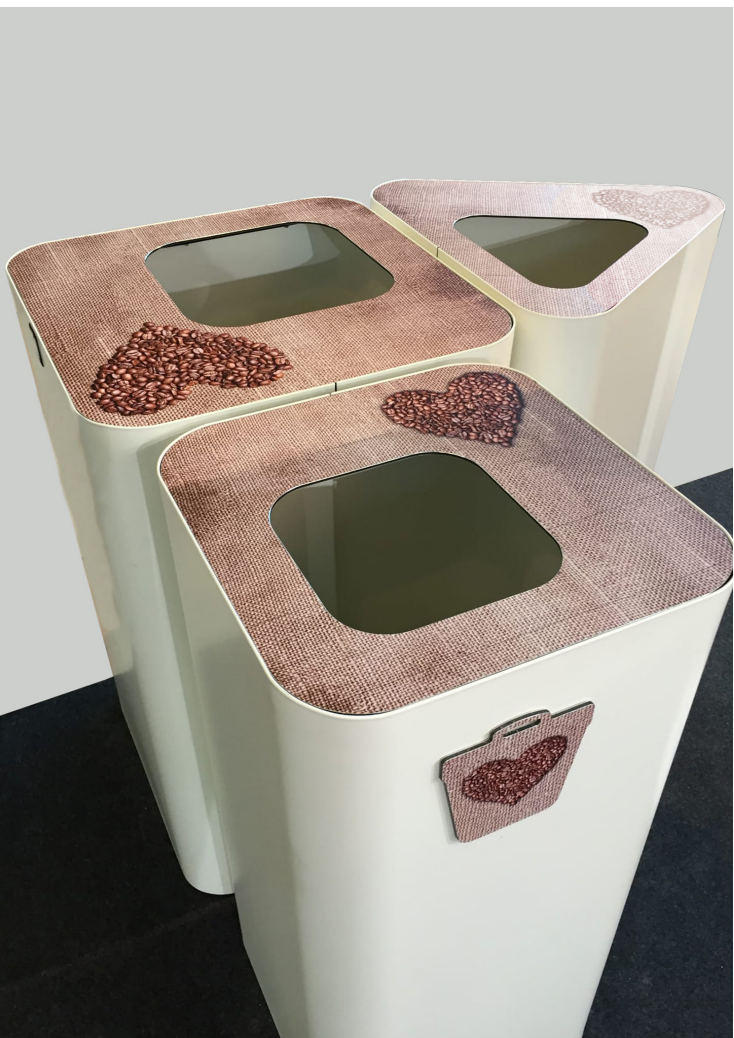





Contenitore per raccolta rifiuti da interno  
Indoor waste bins  
Poubelle pour intérieur



# PURE



Purezza - essenzialità - funzionalità.

Essenziale e puro, il progetto rimarca il proprio concetto con forme pulite, lineari e funzionali, ma cariche di potenza espressiva.

Come nuovo media, PURE, con le sue infinite combinazioni, si integra e coordina con lo stile degli ambienti circostanti, rafforzando l'identità, l'unicità e la riconoscibilità degli spazi stessi grazie alla propria capacità comunicativa.

*Pure. Essential. Functional.*

*Pure and essential. The system points out its concept of purity with clean, linear and functional shapes, rich of expressing power. As a new media, PURE, together with its limitless combinations, suits the style of the surrounding spaces, reinforcing the identity, the uniqueness and the recognizability of the spaces themselves, thanks to its own communicational skill.*

*Pureté - essentialité - fonctionnalité.*

*Essentiel et pur, le projet met l'accent sur son concept avec des formes épurées, linéaires et fonctionnelles, mais pleines de puissance expressive.*

*En tant que nouveau média, PURE, avec ses combinaisons infinies, s'intègre et se coordonne avec le style des environnements, renforçant l'identité, l'unicité et la reconnaissabilité des espaces grâce à sa capacité communicative.*



**Contenitore per raccolta rifiuti da interno**  
**Indoor waste bins**  
**Poubelle pour intérieur**

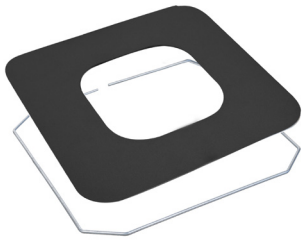

**Cover realizzata in ferro zincato spessore 2 mm. Verniciatura a polveri epossidiche**

Galvanized metal 2 mm thickness cover. Epoxy powder painting. / Couverture en métal galvanisé épaisseur 2 mm. Peinture à poudres époxy

**Tondino di acciaio zincato con funzione blocca sacco**

Galvanized steel bag stopper  
 Fermeture du sac en acier



**Anello perimetrale con funzione reggisacchetto realizzato in tecnopolimero**

Tecopolymer perimetral bag holder ring  
 Anneau périmétral ferme sac en techno-polymère



**Pittogramma Magnetico**

Magnetic pictogram  
 Magnétique Pictogramme



**Lamiera in ferro zincato spessore 0,6 mm. Verniciatura a polveri epossidiche**

0,6 mm thickness galvanized steel.  
 Epoxy powder coating  
 Matériel : acier galvanisé, épaisseur 0,6 mm.  
 Vernis à poudres époxy



**Acciaio inox aisi 430 satinato.**

430 brushed stainless steel.  
 Acier inox brossé aisi 430.

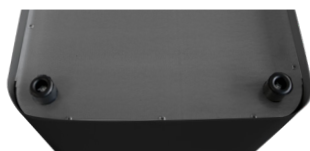

**Fondo in ferro zincato spessore 1 mm. Piedi in tecnopolimero**

1 mm thickness, galvanized steel bottom.  
 Tecopolymer feet  
 Fond en acier épaisseur 1 mm.  
 Pieds en tecnopolymère







1 pittogramma incluso  
1 pictogram included  
1 pictogramme inclus

## PU60F <sup>60L</sup>

30 x 30 x h80 cm, 7 kg

Elegante e funzionale contenitore per raccolta rifiuti, realizzato totalmente in acciaio.

Pratico reggisacco interno con svuotamento dall'alto.

*Elegant and functional waste bin, completely made of steel.*

*Practical inner bag holder, emptying bag from the top.*

*Poubelle élégante et fonctionnelle, produite entièrement en acier.*

*Support-sac et couvercle pratiques, avec vidage par le haut.*

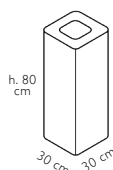

Pittogrammi a pagina 38  
Pictograms at page 38  
Pictogrammes page 38

### PU60F-N02

Fusto e cover acciaio verniciato nero  
Black metal painted body and cover  
Corps et couvercle acier peint noir

### PU60F-G02

Fusto e cover acciaio verniciato grigio  
Grey metal painted body and cover  
Corps et couvercle acier peint gris

### PU60F-B02

Fusto e cover acciaio verniciato bianco  
White metal painted body and cover  
Corps et couvercle acier peint blanc

### PU60F-C02

Fusto e cover acciaio verniciato corten  
Corten metal painted body and cover  
Corps et couvercle acier peint corten

### PU60F-AS02

Fusto in acciaio inox satinato, cover in materiale composito satinato  
Brushed stainless steel body, brushed composit material cover  
Corps en acier inox brossé, couvercle en matériel composé brossé

## PU60F-CD <sup>60L</sup>

30 x 30 x h80 cm, 7 kg

Elegante e funzionale contenitore per raccolta rifiuti, realizzato totalmente in acciaio.

Pratico reggisacco interno con svuotamento dall'alto.

*Elegant and functional waste bin, completely made of steel.*

*Practical inner bag holder, emptying bag from the top.*

*Poubelle élégante et fonctionnelle, produite entièrement en acier.*

*Support-sac et couvercle pratiques, avec vidage par le haut.*

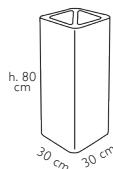

Kit pittogrammi inclusi  
Pictograms kit included  
Kit pictogrammes inclus

### PU60F-CD-N

Fusto e cover acciaio verniciato nero  
Black metal painted body and cover  
Corps et couvercle acier peint noir

### PU60F-CD-G

Fusto e cover acciaio verniciato grigio  
Grey metal painted body and cover  
Corps et couvercle acier peint gris

### PU60F-CD-B

Fusto e cover acciaio verniciato bianco  
White metal painted body and cover  
Corps et couvercle acier peint blanc

### PU60F-CD-C

Fusto e cover acciaio verniciato corten  
Corten metal painted body and cover  
Corps et couvercle acier peint corten

### PU60F-CD-AS

Fusto in acciaio inox satinato, cover in materiale composito satinato  
Brushed stainless steel body, brushed composit material cover  
Corps en acier inox brossé, couvercle en matériel composé brossé





**Contenitore per raccolta rifiuti da interno**  
**Indoor waste bins**  
**Poubelle pour intérieur**

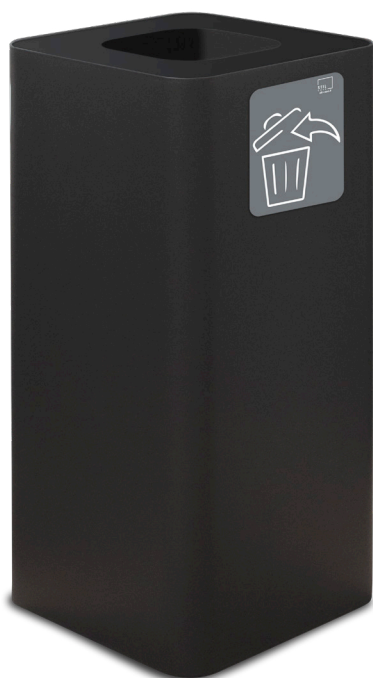

1 pittogramma incluso  
 1 pictogram included  
 1 pictogramme inclus

**PU100F** 

38 x 38 x h80 cm, 9 kg

Elegante e funzionale contenitore per raccolta rifiuti, realizzato totalmente in acciaio.

Pratico reggisacchetto interno con svuotamento dall'alto.

*Elegant and functional waste bin, completely made of steel.*

*Practical inner bag holder, emptying bag from the top.*

*Poubelle élégante et fonctionnelle, produite entièrement en acier.*

*Support-sac et couvercle pratiques, avec vidage par le haut.*

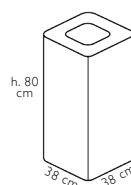

Pittogrammi a pagina 38  
 Pictograms at page 38  
 Pictogrammes page 38

**PU100F-N02**

Fusto e cover acciaio verniciato nero  
 Black metal painted body and cover  
 Corps et couvercle acier peint noir

**PU100F-G02**

Fusto e cover acciaio verniciato grigio  
 Grey metal painted body and cover  
 Corps et couvercle acier peint gris

**PU100F-B02**

Fusto e cover acciaio verniciato bianco  
 White metal painted body and cover  
 Corps et couvercle acier peint blanc

**PU100F-C02**

Fusto e cover acciaio verniciato corten  
 Corten metal painted body and cover  
 Corps et couvercle acier peint corten

**PU100F-AS02**

Fusto in acciaio inox satinato, cover in materiale composito satinato  
 Brushed stainless steel body, brushed composit material cover  
 Corps en acier inox brossé, couvercle en matériel composé brossé



**PU100F-CD** 

38 x 38 x h80 cm, 9 kg

Elegante e funzionale contenitore per raccolta rifiuti, realizzato totalmente in acciaio.

Pratico reggisacchetto interno con svuotamento dall'alto.

*Elegant and functional waste bin, completely made of steel.*

*Practical inner bag holder, emptying bag from the top.*

*Poubelle élégante et fonctionnelle, produite entièrement en acier.*

*Support-sac et couvercle pratiques, avec vidage par le haut.*

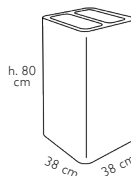

Kit pittogrammi inclusi  
 Pictograms kit included  
 Kit pictogrammes inclus

**PU100F-CD-N**

Fusto e cover acciaio verniciato nero  
 Black metal painted body and cover  
 Corps et couvercle acier peint noir

**PU100F-CD-G**

Fusto e cover acciaio verniciato grigio  
 Grey metal painted body and cover  
 Corps et couvercle acier peint gris

**PU100F-CD-B**

Fusto e cover acciaio verniciato bianco  
 White metal painted body and cover  
 Corps et couvercle acier peint blanc

**PU100F-CD-C**

Fusto e cover acciaio verniciato corten  
 Corten metal painted body and cover  
 Corps et couvercle acier peint corten

**PU100F-CD-AS**

Fusto in acciaio inox satinato, cover in materiale composito satinato  
 Brushed stainless steel body, brushed composit material cover  
 Corps en acier inox brossé, couvercle en matériel composé brossé



**Contenitore per raccolta rifiuti da interno**  
**Indoor waste bins**  
**Poubelle pour intérieur**

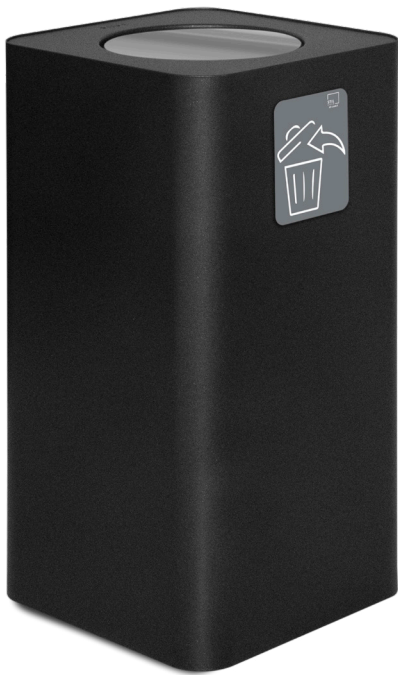

1 pittogramma incluso  
 1 pictogram included  
 1 pictogramme inclus

**PU100F-BA**

38 x 38 x h80 cm, 9 kg

Elegante e funzionale contenitore per raccolta rifiuti con coperchio basculante, realizzato totalmente in acciaio. Pratico reggisacchetto interno con svuotamento dall'alto. Cover con coperchio basculante in acciaio lucido.

*Elegant and functional waste bin with swinging lid, completely made of steel. Practical inner bag holder, emptying bag from the top. Cover with coperchio basculante in acciaio lucido.*

*Poubelle avec couvercle basculant, élégante et fonctionnelle, produite entièrement en acier. Support-sac et couvercle pratiques, avec vidage par le haut. Cover avec couvercle basculant en acier inox brillant.*

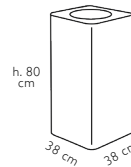

**PU100F-BA-N02**

Fusto e cover acciaio verniciato nero  
 Black metal painted body and cover  
 Corps et couvercle acier peint noir



**PU100F-BA-G02**

Fusto e cover acciaio verniciato grigio  
 Grey metal painted body and cover  
 Corps et couvercle acier peint gris



**PU100F-BA-B02**

Fusto e cover acciaio verniciato bianco  
 White metal painted body and cover  
 Corps et couvercle acier peint blanc



**PU100F-BA-C02**

Fusto e cover acciaio verniciato corten  
 Corten metal painted body and cover  
 Corps et couvercle acier peint corten



Pittogrammi a pagina 38  
 Pictograms at page 38  
 Pictogrammes page 38



**Posacenere e gettacarta per esterno coperto.**  
**Covered outdoor wastebin with ashtray**  
**Poubelle avec cendrier pour extérieur couvert**



2 pittogrammi inclusi  
 2 pictograms included  
 2 pictogrammes inclus

**PU100F-GP**

38 x 38 x h80 cm, 9 kg

Elegante e funzionale contenitore per raccolta rifiuti con posacenere, realizzato totalmente in acciaio. Pratico reggisacchetto interno con svuotamento dall'alto. 1 kg di sabbia incluso.

*Elegant and functional waste bin with ashtray, completely made of steel. Inner bag holder, bag emptying from the top. 1 kg sand included.*

*Poubelle avec cendrier, élégante et fonctionnelle, produite entièrement en acier. Support-sac et couvercle avec vidage par le haut. 1 kg de sable inclus.*

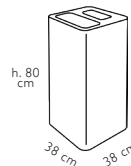

**PU100F-GP-N**

Fusto e cover acciaio verniciato nero  
 Black metal painted body and cover  
 Corps et couvercle acier peint noir



**PU100F-GP-G**

Fusto e cover acciaio verniciato grigio  
 Grey metal painted body and cover  
 Corps et couvercle acier peint gris



**PU100F-GP-B**

Fusto e cover acciaio verniciato bianco  
 White metal painted body and cover  
 Corps et couvercle acier peint blanc



**PU100F-GP-C**

Fusto e cover acciaio verniciato corten  
 Corten metal painted body and cover  
 Corps et couvercle acier peint corten



Pittogrammi a pagina 38  
 Pictograms at page 38  
 Pictogrammes page 38



**PU100F-GP-AS**

Fusto in acciaio inox satinato, cover in materiale composito satinato  
 Brushed stainless steel body, brushed composit material cover  
 Corps en acier inox brossé, couvercle en matériel composé brossé



**Posacenere e gettacarta per esterno coperto.**  
**Covered outdoor wastebin with ashtray**  
**Poubelle avec cendrier pour extérieur couvert**

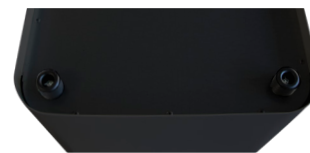
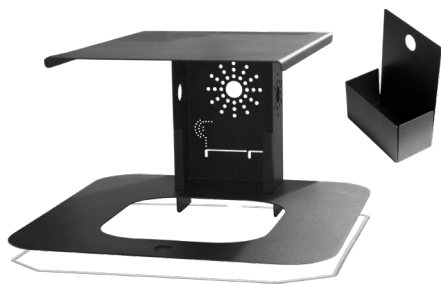

**Testa posacenere in metallo verniciato con copertura superiore. Serigrafia laterale spegni sigaretta.** / Metal painted head with upper cover. Lateral incision to put out cigarettes. / Tête cendrier en métal verni avec couverture supérieure. Incision latéral pour éteindre les cigarettes.

**Inserimento sacchetto tramite anello reggi sacco.** / Bag holder to put in and out trash. / Anneau support sac pour mettre ou enlever les déchets.

**Vaschetta estraibile raccogli mozziconi.** / Extractable tank to empty cigarettes butts. / Bac amovible pour collecter les mégots.

**N**

**Fusto in metallo verniciato a polveri epossidiche.**  
Epoxy powders metal painted body. Brushed composite material pictogram.  
Corp en metal poudré. Pictogramme brossé en matériel composite.

**A**

**Fusto in acciaio inox aisi 430 satinato.**  
Aisi 430 matt stainless steel body. Brushed composite material pictogram.  
Corp en acier inox brossé. Pictogramme brossé en matériel composite.

**Fondo in acciaio zincato spessore 1 mm.**  
**Piedi in tecnopolimero.**

1 mm thickness, galvanized steel bottom.

Tecnopolymer feet. Fond en acier épaisseur 1 mm. Pieds en techno-polymère.



**PU100-TP** 

38 x 38 x h102 cm, 13,5 kg

Elegante e funzionale posacenere, fusto e cover in acciaio. Vaschetta raccogli sigarette in acciaio. 1 kg di sabbia incluso.

*Elegant and functional ashtray, steel made body and cover. Inner metal bowl. 1 kg sand included.*

*Cendrier élégant et fonctionel, corps et couvercle en acier. Bac interieur en acier. 1 kg de sable inclus.*

h. 102 cm

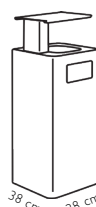

**PU100N-TP**  
Fusto e cover acciaio verniciato nero  
Black metal painted body and cover  
Corps et couvercle acier poudré noir

**PU100A-TP**  
Fusto acciaio inox lucido, cover in acciaio verniciato nero  
Shiny stainless steel body, black metal painted cover  
Corps en acier inox brillant, couvercle en acier poudré noir



**Posacenere e gettacarta per esterno coperto.**  
**Covered outdoor wastebin with ashtray**  
**Poubelle avec cendrier pour extérieur couvert**



**PU60-TP**



30 x 30 x h102 cm, 10,5 kg

Elegante e funzionale posacenere, fusto e cover in acciaio. Vaschetta raccogli sigarette in acciaio. 1 kg di sabbia incluso.

*Elegant and functional ashtray, steel made body and cover. Inner metal bowl. 1 kg sand included.*

*Cendrier élégant et fonctionnel, corps et couvercle en acier. Bac intérieur en acier. 1 kg de sable inclus.*

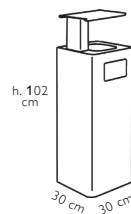

**PU60N-TP**

Fusto e cover acciaio verniciato nero  
 Black metal painted body and cover  
 Corps et couvercle acier poudré noir

**PU60A-TP**

Fusto acciaio inox lucido, cover in acciaio verniciato nero  
 Shiny stainless steel body, black metal painted cover  
 Corps en acier inox brillant, couvercle en acier poudré noir



**Posacenere per esterno coperto.**  
**Covered outdoor ashtray**  
**Cendrier pour extérieur couvert**



**PU50F**

30 x 30 x h65 cm, 6 kg

Elegante e funzionale posacenere, fusto e cover in acciaio. Vaschetta raccogli sigarette e griglia superiore in acciaio. 1 kg di sabbia incluso.

*Elegant and functional ashtray, steel made body and cover. Inner bowl with steel grid. 1 kg sand included.*

*Cendrier élégant et fonctionnel, corp et couvercle en acier. Bac intérieur avec grille en acier. 1 kg de sable inclus.*

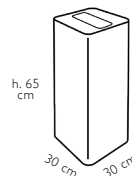

1 pittogramma incluso  
 1 pictogram included  
 1 pictogramme inclus

**PU50F-N07**

Fusto e cover acciaio verniciato nero  
 Black metal painted body and cover  
 Corps et couvercle acier poudré noir

**PU50F-G07**

Fusto e cover acciaio verniciato grigio  
 Grey metal painted body and cover  
 Corps et couvercle acier poudré gris

**PU50F-B07**

Fusto e cover acciaio verniciato bianco  
 White metal painted body and cover  
 Corps et couvercle acier poudré blanc

**PU50F-C07**

Fusto e cover acciaio verniciato corten  
 Corten metal painted body and cover  
 Corps et couvercle acier poudré corten

**PU50F-AS07**

Fusto in acciaio inox satinato, cover in materiale composito satinato  
 Brushed stainless steel body, brushed composit material cover  
 Corps en acier inox brossé, couvercle en matériel composé brossé



**Stazioni per raccolta differenziata da interno**  
**Indoor separate waste station bins**  
**Poubelle tri sélectif pour intérieur**



**Cover realizzata in ferro zincato spessore 2 mm. Verniciatura a polveri epossidiche**

Galvanized metal 2 mm thickness cover. Epoxy powder painting. / Couvercle en métal galvanisé épaisseur 2 mm. Peinture à poudres époxy

**Tondino di acciaio zincato con funzione blocca sacco**

Galvanized steel bag stopper  
Fermeture du sac en acier



**Anello perimetrale con funzione reggisacco realizzato in tecnopolimero**

Tecno-polymer perimetral bag holder ring  
Anneau périmétral ferme sac en tecno-polymère



**Pittogramma Magnetico**

Magnetic pictogram  
Magnétique Pictogramme



**N**

**G**

**B**

**Lamiera in ferro zincato spessore 0,6 mm. Verniciatura a polveri epossidiche**

0,6 mm thickness galvanized steel.  
Epoxy powder coating  
Matériel : acier galvanisé, épaisseur 0,6 mm.  
Vernis à poudres époxy

**AS**

**Acciaio inox aisi 430 satinato.**

430 brushed stainless steel.  
Acier inox brossé aisi 430.

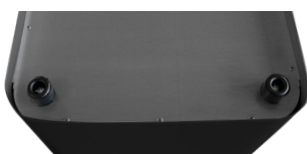

**Fondo in ferro zincato spessore 1 mm. Piedi in tecnopolimero**

1 mm thickness, galvanized steel bottom.  
Tecno-polymer feet  
Fond en acier épaisseur 1 mm.  
Pieds en tecno-polymère



**Stazioni per raccolta differenziata da interno**  
**Indoor separate waste station bins**  
**Poubelle tri sélectif pour intérieur**



**PU120F** 60L + 60L = 120L

60 x 30 x h80 cm, 14 kg

Elegante e funzionale sistema di raccolta rifiuti, realizzato totalmente in acciaio.

Pratico reggisacchetto interno con svuotamento dall'alto.

*Elegant and functional waste collection system, completely made of steel. Practical inner bag holder, emptying bag from the top.*

*Système pour tri sélectif élégant et fonctionnel, produit entièrement en acier. Support-sac et couvercle pratiques, avec vidage par le haut*

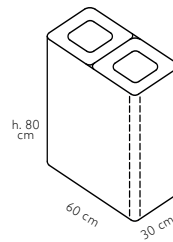

**PU120F-N**  
Fusto e cover acciaio verniciato nero  
Black metal painted body and cover  
Corps et couvercle acier poudré noir

**PU120F-G**  
Fusto e cover acciaio verniciato grigio  
Grey metal painted body and cover  
Corps et couvercle acier poudré gris

**PU120F-B**  
Fusto e cover acciaio verniciato bianco  
White metal painted body and cover  
Corps et couvercle acier poudré blanc

**PU120F-C**  
Fusto e cover acciaio verniciato corten  
Corten metal painted body and cover  
Corps et couvercle acier poudré corten

**PU120F-AS**  
Fusto in acciaio inox satinato, cover in materiale composito satinato  
Brushed stainless steel body, brushed composit material cover  
Corps en acier inox brossé, couvercle en matériel composé brossé



Kit pictogrammi inclusi  
Pictograms kit included  
Kit pictogrammes inclus

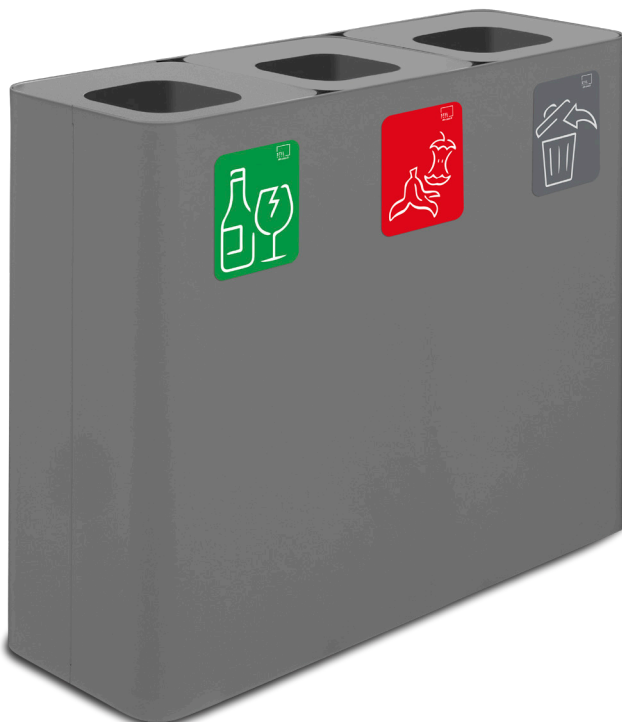

**PU180F** 60L + 60L + 60L = 180L

90 x 30 x h80 cm, 21 kg

Elegante e funzionale sistema di raccolta rifiuti, realizzato totalmente in acciaio. Pratico reggisacchetto interno con svuotamento dall'alto.

*Elegant and functional waste collection system, completely made of steel. Practical inner bag holder, emptying bag from the top.*

*Système pour tri sélectif élégant et fonctionnel, produit entièrement en acier. Support-sac et couvercle pratiques, avec vidage par le haut.*

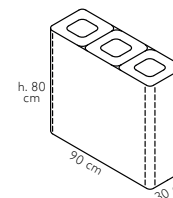

**PU180F-N**  
Fusto e cover acciaio verniciato nero  
Black metal painted body and cover  
Corps et couvercle acier poudré noir

**PU180F-G**  
Fusto e cover acciaio verniciato grigio  
Grey metal painted body and cover  
Corps et couvercle acier poudré gris

**PU180F-B**  
Fusto e cover acciaio verniciato bianco  
White metal painted body and cover  
Corps et couvercle acier poudré blanc

**PU180F-C**  
Fusto e cover acciaio verniciato corten  
Corten metal painted body and cover  
Corps et couvercle acier poudré corten

**PU180F-AS**  
Fusto in acciaio inox satinato, cover in materiale composito satinato  
Brushed stainless steel body, brushed composit material cover  
Corps en acier inox brossé, couvercle en matériel composé brossé



Kit pictogrammi inclusi  
Pictograms kit included  
Kit pictogrammes inclus





**Stazioni per raccolta differenziata da interno**  
**Indoor separate waste station bins**  
**Poubelle tri sélectif pour intérieur**



**PU240F** 60L + 60L + 60L + 60L = 240L

120 x 30 x h80 cm, 28 kg

Elegante e funzionale sistema di raccolta rifiuti, realizzato totalmente in acciaio. Pratico reggisacco interno con svuotamento dall'alto.

*Elegant and functional waste collection system, completely made of steel. Practical inner bag holder, emptying bag from the top.*

*Système pour tri sélectif élégant et fonctionnel, produit entièrement en acier. Support-sac et couvercle pratiques, avec vidage par le haut.*

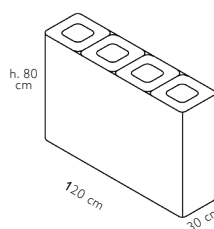

**PU240F-N**

Fusto e cover acciaio verniciato nero  
 Black metal painted body and cover  
 Corps et couvercle acier peint noir

**PU240F-G**

Fusto e cover acciaio verniciato grigio  
 Grey metal painted body and cover  
 Corps et couvercle acier peint gris

**PU240F-B**

Fusto e cover acciaio verniciato bianco  
 White metal painted body and cover  
 Corps et couvercle acier peint blanc

**PU240F-C**

Fusto e cover acciaio verniciato corten  
 Corten metal painted body and cover  
 Corps et couvercle acier peint corten

**PU240F-AS**

Fusto in acciaio inox satinato, cover in materiale composito satinato  
 Brushed stainless steel body, brushed composit material cover  
 Corps en acier inox brossé, couvercle en matériel composé brossé



Kit pittogrammi inclusi  
 Pictograms kit included  
 Kit pictogrammes inclus

**PU140F** 70L + 70L = 140L

80 x 38 x h50 cm, 14 kg

Elegante e funzionale sistema di raccolta rifiuti, realizzato totalmente in acciaio.

Pratico reggisacco interno con svuotamento dall'alto.

*Elegant and functional waste collection system, completely made of steel. Practical inner bag holder, emptying bag from the top.*

*Système pour tri sélectif élégant et fonctionnel, produit entièrement en acier. Support-sac et couvercle pratiques, avec vidage par le haut.*

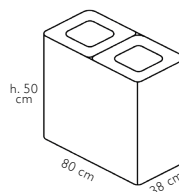
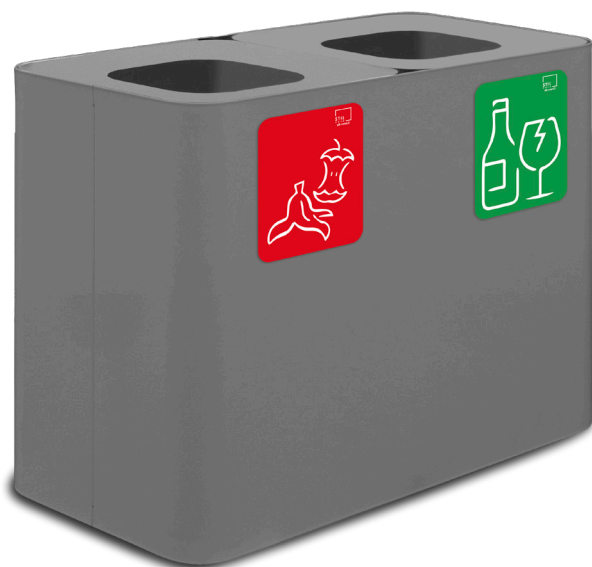

**PU140F-N**

Fusto e cover acciaio verniciato nero  
 Black metal painted body and cover  
 Corps et couvercle acier peint noir

**PU140F-G**

Fusto e cover acciaio verniciato grigio  
 Grey metal painted body and cover  
 Corps et couvercle acier peint gris

**PU140F-B**

Fusto e cover acciaio verniciato bianco  
 White metal painted body and cover  
 Corps et couvercle acier peint blanc

**PU140F-C**

Fusto e cover acciaio verniciato corten  
 Corten metal painted body and cover  
 Corps et couvercle acier peint corten

**PU140F-AS**

Fusto in acciaio inox satinato, cover in materiale composito satinato  
 Brushed stainless steel body, brushed composit material cover  
 Corps en acier inox brossé, couvercle en matériel composé brossé



Kit pittogrammi inclusi  
 Pictograms kit included  
 Kit pictogrammes inclus



**Stazioni per raccolta differenziata da interno**  
**Indoor separate waste station bins**  
**Poubelle tri sélectif pour intérieur**



**PU200F**



77 x 38 x h80 cm, 18 kg

Elegante e funzionale sistema di raccolta rifiuti, realizzato totalmente in acciaio. Pratico reggisacchetto interno con svuotamento dall'alto.

*Elegant and functional waste collection system, completely made of steel. Practical inner bag holder, emptying bag from the top.*

*Système pour tri sélectif élégant et fonctionnel, produit entièrement en acier. Support-sac et couvercle pratiques, avec vidage par le haut.*

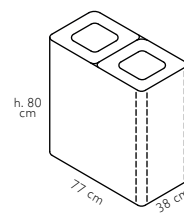

Kit pittogrammi inclusi  
 Pictograms kit included  
 Kit pictogrammes inclus

**PU200F-N**

Fusto e cover acciaio verniciato nero  
 Black metal painted body and cover  
 Corps et couvercle acier peint noir

**PU200F-G**

Fusto e cover acciaio verniciato grigio  
 Grey metal painted body and cover  
 Corps et couvercle acier peint gris

**PU200F-B**

Fusto e cover acciaio verniciato bianco  
 White metal painted body and cover  
 Corps et couvercle acier peint blanc

**PU180F-C**

Fusto e cover acciaio verniciato corten  
 Corten metal painted body and cover  
 Corps et couvercle acier peint corten

**PU200F-AS**

Fusto in acciaio inox satinato, cover in materiale composito satinato  
 Brushed stainless steel body, brushed composit material cover  
 Corps en acier inox brossé, couvercle en matériel composé brossé



**PU300F**



115 x 38 x h80 cm, 27 kg

Elegante e funzionale sistema di raccolta rifiuti, realizzato totalmente in acciaio. Pratico reggisacchetto interno con svuotamento dall'alto.

*Elegant and functional waste collection system, completely made of steel. Practical inner bag holder, emptying bag from the top.*

*Système pour tri sélectif élégant et fonctionnel, produit entièrement en acier. Support-sac et couvercle pratiques, avec vidage par le haut.*

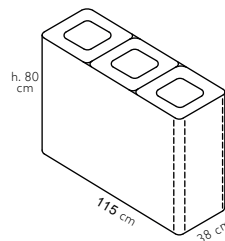

Kit pittogrammi inclusi  
 Pictograms kit included  
 Kit pictogrammes inclus

**PU300F-N**

Fusto e cover acciaio verniciato nero  
 Black metal painted body and cover  
 Corps et couvercle acier peint noir

**PU300F-G**

Fusto e cover acciaio verniciato grigio  
 Grey metal painted body and cover  
 Corps et couvercle acier peint gris

**PU300F-B**

Fusto e cover acciaio verniciato bianco  
 White metal painted body and cover  
 Corps et couvercle acier peint blanc

**PU300F-C**

Fusto e cover acciaio verniciato corten  
 Corten metal painted body and cover  
 Corps et couvercle acier peint corten

**PU300F-AS**

Fusto in acciaio inox satinato, cover in materiale composito satinato  
 Brushed stainless steel body, brushed composit material cover  
 Corps en acier inox brossé, couvercle en matériel composé brossé



Stazioni per raccolta differenziata da interno  
Indoor separate waste station bins  
Poubelle tri sélectif pour intérieur



**COPERCHIO BASCULANTE**  
**SWING LID**  
**COUVERCLE BASCULANT**





**Stazioni per raccolta differenziata da interno**  
**Indoor separate waste station bins**  
**Poubelle tri sélectif pour intérieur**



**PU200F-BA**  +  = 

77 x 38 x h80 cm, 18 kg

Elegante e funzionale sistema di raccolta rifiuti, realizzato totalmente in acciaio. Cover con coperchio basculante in acciaio lucido. Pratico reggisacco interno con svuotamento dall'alto.

*Elegant and functional waste collection system, completely made of steel. Practical inner bag holder, emptying bag from the top. Cover with coperchio basculante in acciaio lucido.*

*Système pour tri sélectif élégant et fonctionnel, produit entièrement en acier. Support-sac et couvercle pratiques, avec vidage par le haut. Cover avec couvercle basculant en acier inox brillant.*

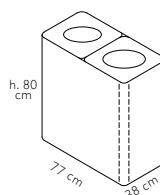

**PU200F-BA-N**  
 Fusto e cover acciaio verniciato nero  
 Black metal painted body and cover  
 Corps et couvercle acier poudré noir

**PU200F-BA-G**  
 Fusto e cover acciaio verniciato grigio  
 Grey metal painted body and cover  
 Corps et couvercle acier poudré gris

**PU200F-BA-B**  
 Fusto e cover acciaio verniciato bianco  
 White metal painted body and cover  
 Corps et couvercle acier poudré blanc

**PU200F-BA-C**  
 Fusto e cover acciaio verniciato corten  
 Corten metal painted body and cover  
 Corps et couvercle acier poudré corten



Kit pittogrammi inclusi  
 Pictograms kit included  
 Kit pictogrammes inclus

**PU300F-BA**  +  +  = 

115 x 38 x h80 cm, 27 kg

Elegante e funzionale sistema di raccolta rifiuti, realizzato totalmente in acciaio. Cover con coperchio basculante in acciaio lucido. Pratico reggisacco interno con svuotamento dall'alto.

*Elegant and functional waste collection system, completely made of steel. Practical inner bag holder, emptying bag from the top. Cover with stainless steel shiny swing lid.*

*Système pour tri sélectif élégant et fonctionnel, produit entièrement en acier. Support-sac et couvercle pratiques, avec vidage par le haut. Cover avec couvercle basculant en acier inox brillant.*

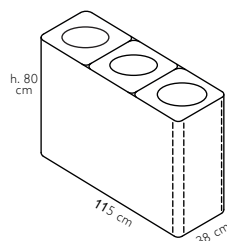

**PU300F-BA-N**  
 Fusto e cover acciaio verniciato nero  
 Black metal painted body and cover  
 Corps et couvercle acier poudré noir

**PU300F-BA-G**  
 Fusto e cover acciaio verniciato grigio  
 Grey metal painted body and cover  
 Corps et couvercle acier poudré gris

**PU300F-BA-B**  
 Fusto e cover acciaio verniciato bianco  
 White metal painted body and cover  
 Corps et couvercle acier poudré blanc

**PU300F-BA-C**  
 Fusto e cover acciaio verniciato corten  
 Corten metal painted body and cover  
 Corps et couvercle acier poudré corten



Kit pittogrammi inclusi  
 Pictograms kit included  
 Kit pictogrammes inclus





PURE

C U S T O M



## IL PROGETTO

La sagoma essenziale del contenitore, la cover personalizzabile con stampe e/o incisioni, la elevata resistenza del materiale, rendono PURE unici e altamente versatili, consentendo infinite combinazioni di forme e colori per adattarsi ed integrarsi in ogni contesto.

L'adozione di tecnologie di ultima generazione, quali l'incisione e la stampa digitale ad alta definizione, consentono la personalizzazione di ogni contenitore sul quale potranno essere restituiti graficamente, loghi e/o grafiche esclusive.

Non esitate a contattare il nostro ufficio tecnico a: [grafica@stil-casa.it](mailto:grafica@stil-casa.it)

## THE PROJECT

*The essential bin's shape, the cover's customization with print or engravings, the material high resistance, make PURE uniques and very versatile, with a lot of shapes and colors combinations to be able to adapt them at every context.*

*The adoption of last generation technologies, like engraving and high definition digital print, allows the customization of every proposed bin with your exclusive graphics and logos.*

*Don't hesitate to e-mail our graphic department: [grafica@stil-casa.it](mailto:grafica@stil-casa.it)*

## LE PROJET

*La silhouette essentielle du conteneur, le couvercle personnalisable avec impression ou gravure, l'haute résistance du matériel, rendent PURE unique et versatile, permettent plusieurs combinaisons de formes et couleurs pour s'adapter à tous les contextes.*

*L'adoption de technologies de dernière génération, comme la gravure et l'impression digitale en haute définition, permettent la personnalisation de tous les conteneurs proposés avec vos graphiques ou logos exclusifs.*

*Contactez-nous pour plusieurs informations: [grafica@stil-casa.it](mailto:grafica@stil-casa.it)*





Contenitore per raccolta differenziata da interno  
Indoor separate wastebin  
Poubelle tri sélectif pour intérieur



# FRONT



Cover superiore in metallo verniciato con chiusura a serratura. / Metal painted cover with security lock. / Couvercle supérieure en métal verni avec serrure de sécurité.



Elastico ferma sacco interno.  
Inner bag holder elastic.  
Elastique intérieur pour supporter le sac.



Fusto in metallo verniciato a polveri epossidiche. / Epoxy painted metal body. / Corp en métal verni à poudre époxyde.

Pittogramma magnetico. / Magnetic pictogram. / Pictogram magnétique.



Fondo con base di sollevamento da terra di 2 cm.  
Bottom with 2 cm ground lifting base. / Fond avec base de soulèvement du sol de 2 cm.



**Contenitore per raccolta differenziata da interno**  
**Indoor separate wastebin**  
**Poubelle tri sélectif pour intérieur**



**747** 

44,5 x 35 x h84 cm, 13 kg

Elegante e funzionale contenitore per raccolta rifiuti, realizzato totalmente in acciaio. Pratico reggisacchetto interno con svuotamento frontale.

*Elegant and functional waste bin, completely made of steel. Practical inner bag holder, emptying bag from the front.*

*Poubelle élégante et fonctionnelle, produite entièrement en acier. Support-sac et couvercle pratiques, avec vidage par le front.*

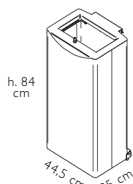

1 pictogramma incluso  
 1 pictogram included  
 1 pictogramme inclus



**747-N**

Fusto e cover acciaio verniciato nero  
 Black metal painted body and cover  
 Corps et couvercle acier poudré noir



Altri pictogrammi a pagina 39  
 Other pictograms at page 39  
 Autres pictogrammes à la page 39



**746** 

44,5 x 35 x h70 cm, 10 kg

Elegante e funzionale contenitore per raccolta rifiuti, realizzato totalmente in acciaio. Pratico reggisacchetto interno con svuotamento frontale.

*Elegant and functional waste bin, completely made of steel. Practical inner bag holder, emptying bag from the front.*

*Poubelle élégante et fonctionnelle, produite entièrement en acier. Support-sac et couvercle pratiques, avec vidage par le front.*

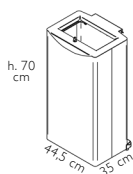

1 pictogramma incluso  
 1 pictogram included  
 1 pictogramme inclus



**746-N**

Fusto e cover acciaio verniciato nero  
 Black metal painted body and cover  
 Corps et couvercle acier poudré noir



Altri pictogrammi a pagina 39  
 Other pictograms at page 39  
 Autres pictogrammes à la page 39





Contenitore per raccolta differenziata da interno  
Indoor separate wastebin  
Hubbell



## COMPOSIZIONE

Composition

Composition



Coperchio in plastica nero.  
Elastico ferma sacco.  
Maniglia in tecnopolimero grigio.

Grey plastic lid. Bag holder elastic. High resistant inner contour.

Grey painted tecnopolymer handle.

Couvercle en plastique noir.

Elastique ferme sac.

Poignée en tecnopolymère grise.



N

Fusto e placca superiore del coperchio in metallo verniciato a polveri epossidiche nere.

Black metal painted body and upper lid's plate.

Corp et plaque supérieure du couvercle en metal poudré noir.

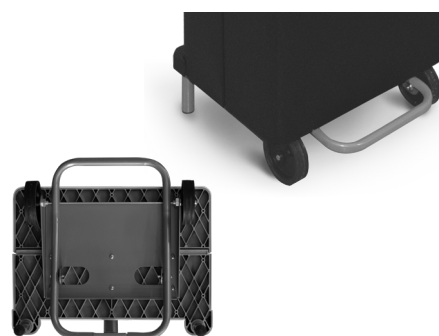

Fondo in tecnopolimero ad alta resistenza. Pedale e piedi posteriori d'appoggio in tubolare di metallo verniciato grigio. Ruote in plastica con perni.

High resistance plastic lower base.

Grey metal painted pedal and rear feet's support.

Plastic wheels with hubs

Base en plastique à haute résistance. Pédale et support postérieur en poudré gris. Roues en plastique avec pivots.



**745** 110L

47 x 37 x h96 cm, 13 kg

Elegante e funzionale contenitore per raccolta rifiuti, realizzato totalmente in acciaio. Svuotamento frontale.

*Elegant and functional waste bin, completely made of steel. Frontal bag emptying.*

*Poubelle élégante et fonctionnelle, produite entièrement en acier. Vidage sac frontal.*

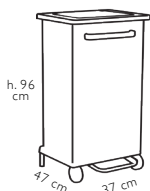

**745 N/110**

Acciaio verniciato nero  
Black painted steel  
Acier poudré noir



Altri pittogrammi a pagina 38  
Other pictograms at page 38  
Autres pictogrammes à la page 38



**744** 90L

47 x 37 x h83 cm, 12 kg

Elegante e funzionale contenitore per raccolta rifiuti, realizzato totalmente in acciaio. Svuotamento frontale.

*Elegant and functional waste bin, completely made of steel. Frontal bag emptying.*

*Poubelle élégante et fonctionnelle, produite entièrement en acier. Vidage sac frontal.*



**744 N/90**

Acciaio verniciato nero  
Black painted steel  
Acier poudré noir



Altri pittogrammi a pagina 38  
Other pictograms at page 38  
Autres pictogrammes à la page 38



**743** 70L

47 x 37 x h70 cm, 11 kg

Elegante e funzionale contenitore per raccolta rifiuti, realizzato totalmente in acciaio. Svuotamento frontale.

*Elegant and functional waste bin, completely made of steel. Frontal bag emptying.*

*Poubelle élégante et fonctionnelle, produite entièrement en acier. Vidage sac frontal.*

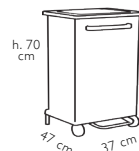

**743 N/70**

Acciaio verniciato nero  
Black painted steel  
Acier poudré noir



Altri pittogrammi a pagina 38  
Other pictograms at page 38  
Autres pictogrammes à la page 38

da interno  
ebins  
pour intérieur



# ROUND



Ricca gamma di contenitori per raccolta differenziata dalla sagoma morbida ed elegante.  
Tutti i prodotti sono dotati di pratico svuotamento dall'alto, grazie alla cover superiore e agli anelli reggi sacco interni.

Riciclaggio a tutto tondo!

*A wide range of soft and elegant round shape recycling wastebins.  
All products are finished with an upper cover and inner bag holder rings to facilitate the waste emptying.*

*All round recycling!*

*Vaste gamme de conteneurs pour le tri sélectif avec une élégante et douce silhouette.  
Tous les produits permettent le vidage par le haute grace aux couvercles supérieurs et aux anneaux porte sacs.*

*Ronde recyclage!*



**Contenitori da interno**  
**Indoor wastebins**  
**Poubelles pour intérieur**

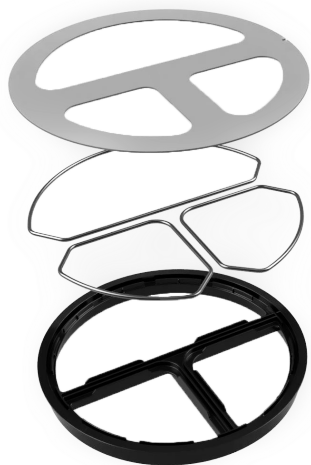

**Cover realizzata in acciaio zincato.**  
**Verniciatura a polveri epossidiche**

Galvanized steel cover. Epoxy powder painting.  
Couvercle en métal galvanisé épaisseur 2 mm. Peinture à poudres époxy

**Tondino di acciaio zincato con funzione blocca sacco**

Galvanized steel bag stopper  
Fermeture du sac en acier

**Anello perimetrale con funzione reggisacco realizzato in tecnopolimero**

Tecopolymer perimetral bag holder ring  
Anneau périmétral ferme sac en tecno-polymère



**Pittogramma Magnetico**

Magnetic pictogram  
Magnétique Pictogramme

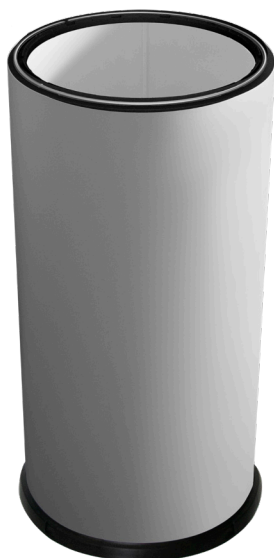

**Acciaio verniciato a polveri epossidiche.**

Epoxy powder coating steel.  
Acier poudré.



**Fondo in ferro zincato, anello salva pavimento in plastica.**

Metal bottom with floor-saving ring.  
Base en métal avec anneau sauve sol.



**Contenitori da interno**  
**Indoor wastebins**  
**Poubelles pour intérieur**

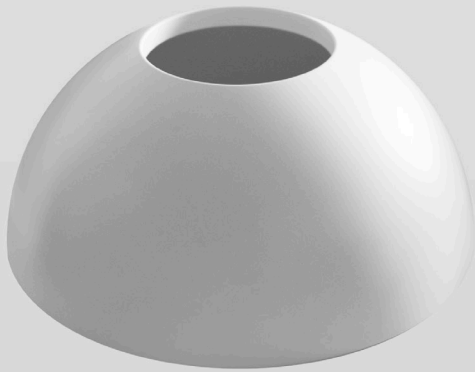

**Testa in metallo verniciato semi-sferica con foro getta rifiuti.**  
Metal painted spherical trash bin.  
Tête semi-sphère en métal verni avec trou pour jeter les déchets.



**Testa push in metallo verniciato con apertura a spinta.**  
Metal painted push head opening.  
Tête en métal verni avec ouverture basculant.

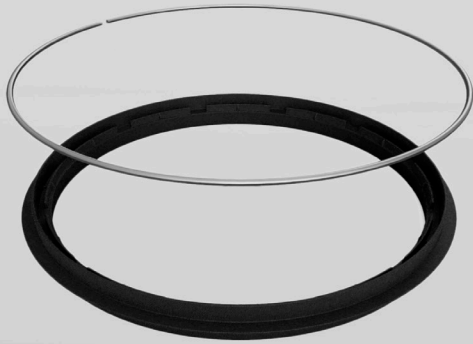

**Inserimento sacchetto tramite anello reggi sacco.**  
Bag holder to put in and out trash.  
Anneau support sac pour mettre ou enlever les déchets.

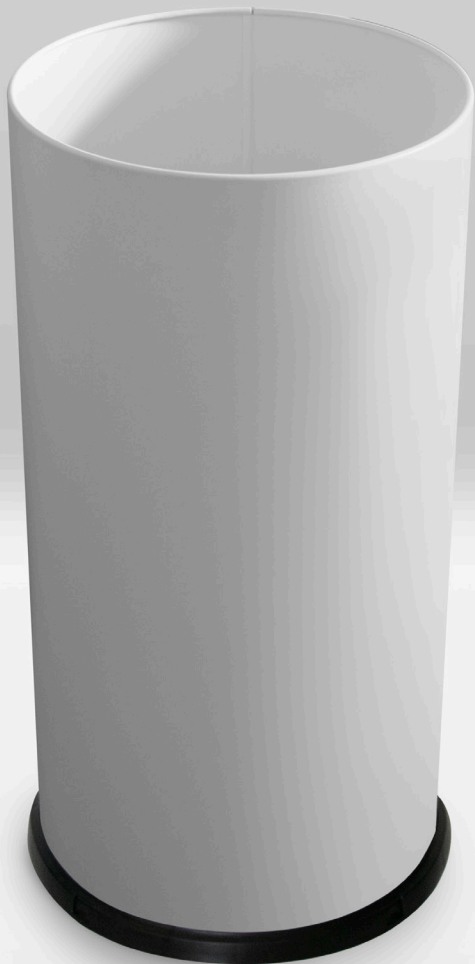

**Fusto in metallo verniciato a polveri epossidiche.**  
Epoxy powders metal painted body.  
Corps en métal verni à poudre époxyde.

**Fondo in metallo con bordino salva pavimento.**  
Metal bottom with floor-saving ring.  
Base en métal avec anneau save sol.



**Contenitori da interno**  
**Indoor wastebins**  
**Poubelles pour intérieur**



**838**



Ø 35 x h88 cm, 5,5 kg

Elegante e funzionale sistema di raccolta rifiuti, realizzato totalmente in acciaio.

Pratico reggisacchetto interno con svuotamento dall'alto.

*Elegant and functional waste collection system, completely made of steel. Practical inner bag holder, emptying bag from the top.*

*Système pour tri sélectif élégant et fonctionnel, produit entièrement en acier. Support-sac et couvercle pratiques, avec vidage par le haut.*

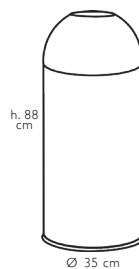

**838 N**

● Acciaio verniciato nero  
Black painted steel  
Acier poudré noir

**838 G**

● Acciaio verniciato grigio  
Grey painted steel  
Acier poudré gris

**838 B**

● Acciaio verniciato bianco  
White painted steel  
Acier poudré blanc



**839**



Ø 35 x h92 cm, 5 kg

Elegante e funzionale contenitore per raccolta rifiuti, con apertura Push, realizzato totalmente in acciaio.

Pratico reggisacchetto interno con svuotamento dall'alto.

*Elegant and functional waste collection bin with push opening, completely made of steel. Practical inner bag holder, emptying bag from the top.*

*Système pour tri sélectif élégant et fonctionnel, produit entièrement en acier. Support-sac et couvercle pratiques, avec vidage par le haut.*

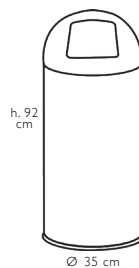

**839 N**

● Acciaio verniciato nero  
Black painted steel  
Acier poudré noir

**839 G**

● Acciaio verniciato grigio  
Grey painted steel  
Acier poudré gris

**839 B**

● Acciaio verniciato bianco  
White painted steel  
Acier poudré blanc



**Contenitori da interno**  
**Indoor wastebins**  
**Poubelles pour intérieur**



**Cover superiore in metallo verniciato a polveri epossidiche.**

Metal upper cover painted with epoxy powder.

Couvercle supérieur en métal verni avec poudres epoxydes.

**Inserimento sacchetto tramite anello reggi sacco con profilo in tecnopolimero ad alta resistenza.**

Bag holder to put in and out trash with high resistant plastic contour.  
Anneau support sac pour mettre ou enlever les déchets avec profil en plastique en haute résistance.



**Pittogramma magnetico**

Magnetic pictogram

Pictogramme magnétique.



**Fusto in metallo verniciato a polveri epossidiche.**

Metal body painted with epoxy powder.

Corp en metal verni avec poudres epoxydes.

**Fondo in metallo con bordino salva pavimento.**

Metal bottom with floor-saving ring.

Base en métal avec anneau save sol.

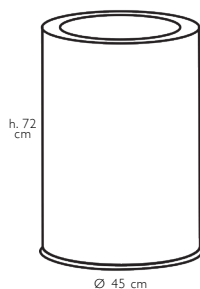

**991** 

Ø 45 x h72 cm, 6,5 kg

Elegante e funzionale contenitore per raccolta rifiuti, cover a uno scomparto, realizzato totalmente in acciaio e verniciato con vernici termoindurenti.

Pratico reggisacchetto interno con svuotamento dall'alto.

*Elegant and functional wastebin with one single compartment, completely made of steel. Practical inner bag holder, emptying bag from the top.*

*Poubelle à un compartiment élégante et fonctionnelle, produite entièrement en acier. Support-sac et couvercle pratiques, avec vidage par le haut.*

**991 G**  
Acciaio verniciato grigio  
Grey painted steel  
Acier poudré gris

**991 N**  
Acciaio verniciato nero  
Black painted steel  
Acier poudré noir



1 pictogramma incluso  
1 pictogram included  
1 pictogramme inclus



Pittogrammi a pagina 39  
Pictograms at page 39  
Pictogrammes page 39



**Contenitori da interno**  
**Indoor wastebins**  
**Poubelles pour intérieur**

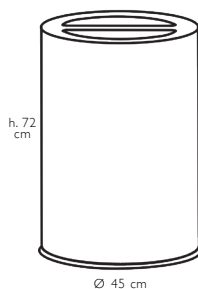
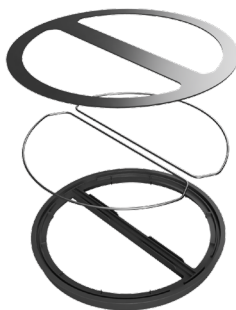

h. 72  
cm

Ø 45 cm

**992** 50L + 50L = 100L

Ø 45 x h72 cm, 6,5 kg

Elegante e funzionale contenitore per raccolta rifiuti, cover a due scomparti, realizzato totalmente in acciaio e verniciato con vernici termoindurenti.

Pratico reggisacchetto interno con svuotamento dall'alto.

*Elegant and functional wastebin with two compartments, completely made of steel. Practical inner bag holder, emptying bag from the top.*

*Poubelle à deux compartiments élégante et fonctionnelle, produite entièrement en acier. Support-sac et couvercle pratiques, avec vidage par le haut.*



**992 N**  
Acciaio verniciato nero  
Black painted steel  
Acier peint noir

**992 G**  
Acciaio verniciato grigio  
Grey painted steel  
Acier peint gris

4 pictogrammi inclusi  
4 pictograms included  
4 pictogrammes inclus

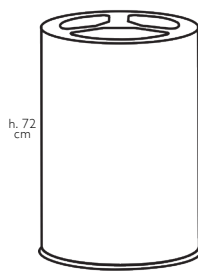
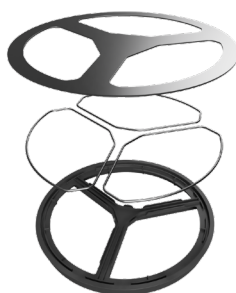

h. 72  
cm

Ø 45 cm

**993** 33L + 33L + 33L = 100L

Ø 45 x h72 cm, 6,5 kg

Elegante e funzionale contenitore per raccolta rifiuti, cover a tre scomparti, realizzato totalmente in acciaio e verniciato con vernici termoindurenti.

Pratico reggisacchetto interno con svuotamento dall'alto.

*Elegant and functional wastebin with three compartments, completely made of steel. Practical inner bag holder, emptying bag from the top.*

*Poubelle à trois compartiments élégante et fonctionnelle, produite entièrement en acier. Support-sac et couvercle pratiques, avec vidage par le haut.*



**993 N**  
Acciaio verniciato nero  
Black painted steel  
Acier peint noir

**993 G**  
Acciaio verniciato grigio  
Grey painted steel  
Acier peint gris

4 pictogrammi inclusi  
4 pictograms included  
4 pictogrammes inclus





**Contenitori da interno**  
**Indoor wastebins**  
**Poubelles pour intérieur**



**Cover superiore in metallo verniciato a polveri epossidiche.**

Metal upper cover painted with epoxy powder.

Couvercle supérieur en metal verni avec poudres epoxydes.

**Inserimento sacchetto tramite anello reggi sacco con profilo in tecnopolimero ad alta resistenza.**

Bag holder to put in and out trash with high resistant plastic contour.

Anneau support sac pour mettre ou enlever les déchets avec profil en plastique en haute résistance.



**Pittogramma magnetico**

magnetic pictogram  
pictogram magnétique.



**Fusto in metallo verniciato a polveri epossidiche.**

Metal body painted with epoxy powder.

Corp en metal verni avec poudres epoxydes.

**Fondo in metallo con bordino salva pavimento.**

Metal bottom with floor-saving ring.

Base en métal avec anneau sauve sol.

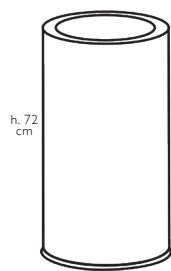

**871** <sup>70L</sup>

Ø 35 x h72 cm, 4,9 kg

Elegante e funzionale contenitore per raccolta rifiuti, cover a uno scomparto, realizzato totalmente in acciaio e verniciato con vernici termoindurenti.

Pratico reggisacchetto interno con svuotamento dall'alto.

*Elegant and functional wastebin with one single compartment, completely made of steel. Practical inner bag holder, emptying bag from the top.*

*Poubelle à un compartiment élégante et fonctionnelle, produite entièrement en acier. Support-sac et couvercle pratiques, avec vidage par le haut.*

**871 G**  
Acciaio verniciato grigio  
Grey painted steel  
Acier poudré gris

**871 N**  
Acciaio verniciato nero  
Black painted steel  
Acier poudré noir



1 pictogramma incluso  
1 pictogram included  
1 pictogramme inclus



Pictogrammi a pagina 39  
Pictograms at page 39  
Pictogrammes page 39



**Contenitori da interno**  
**Indoor wastebins**  
**Poubelles pour intérieur**

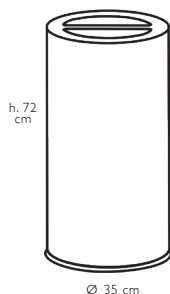

**872** + =

Ø 35 x h72 cm, 4,9 kg

Elegante e funzionale contenitore per raccolta rifiuti, cover a due scomparti, realizzato totalmente in acciaio e verniciato con vernici termoindurenti.

Pratico reggisacchetto interno con svuotamento dall'alto.

*Elegant and functional wastebin with two compartments, completely made of steel. Practical inner bag holder, emptying bag from the top.*

*Poubelle à trois compartiments élégante et fonctionnelle, produite entièrement en acier. Support-sac et couvercle pratiques, avec vidage par le haut.*



**872 N**

Acciaio verniciato nero  
Black painted steel  
Acier poudré noir

**872 G**

Acciaio verniciato grigio  
Grey painted steel  
Acier poudré gris

4 pittogrammi inclusi  
4 pictograms included  
4 pictogrammes inclus

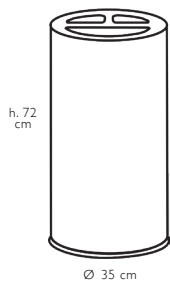

**873** + + =

Ø 35 x h72 cm, 4,9 kg

Elegante e funzionale contenitore per raccolta rifiuti, cover a tre scomparti, realizzato totalmente in acciaio e verniciato con vernici termoindurenti.

Pratico reggisacchetto interno con svuotamento dall'alto.

*Elegant and functional wastebin with three compartments, completely made of steel. Practical inner bag holder, emptying bag from the top.*

*Poubelle à trois compartiments élégante et fonctionnelle, produite entièrement en acier. Support-sac et couvercle pratiques, avec vidage par le haut.*

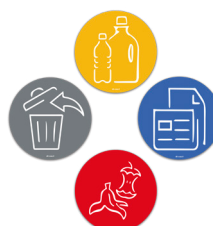

**873 N**

Acciaio verniciato nero  
Black painted steel  
Acier poudré noir

**873 G**

Acciaio verniciato grigio  
Grey painted steel  
Acier poudré gris

4 pittogrammi inclusi  
4 pictograms included  
4 pictogrammes inclus



Contenitori da interno  
Indoor wastebins  
Poubelles pour intérieur



**COPERCHIO BASCULANTE**  
**SWING LID**  
**COUVERCLE BASCULANT**





**Contenitori da interno**  
**Indoor wastebins**  
**Poubelles pour intérieur**



**Cover superiore in acciaio verniciato; coperchio basculante in acciaio lucido.**  
Painted steel upper cover with shiny steel swing lid.

Anneau supérieur en acier poudré avec couvercle basculant en acier brillant.

**Inserimento sacchetto tramite anello reggi sacco con profilo in tecnopolimero ad alta resistenza.**

Bag holder to put in and out trash with high resistant plastic contour. Anneau support sac pour mettre ou enlever les déchets avec profil en plastique en haute résistance.



**Pittogramma magnetico**  
magnetic pictogram  
pictogram magnétique.



**Fusto in metallo verniciato a polveri epossidiche.**  
Metal body painted with epoxy powder.  
Corp en metal verni avec poudres epoxydes.

**Fondo in metallo con bordino salva pavimento.**  
Metal bottom with floor-saving ring.  
Base en métal avec anneau save sol.

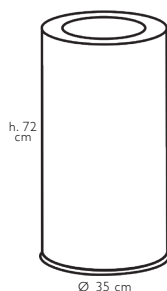

h. 72 cm

Ø 35 cm

**874** 

Ø 35 x h70 cm, 5,4 kg

Elegante e funzionale contenitore per raccolta rifiuti, cover con coperchio basculante, realizzato totalmente in acciaio e verniciato con vernici termoindurenti. Pratico reggisacchetto interno con svuotamento dall'alto.

*Elegant and functional wastebin with swing lid, completely made of steel. Practical inner bag holder, emptying bag from the top.*

*Poubelle avec couvercle basculant élégante et fonctionnelle, produite entièrement en acier. Support-sac et couvercle pratiques, avec vidage par le haut.*

**874 G**  
Acciaio verniciato grigio  
Grey painted steel  
Acier poudré gris

**874 N**  
Acciaio verniciato nero  
Black painted steel  
Acier poudré noir



1 pittogramma incluso  
1 pictogram included  
1 pictogramme inclus

Pittogrammi a pagina 39  
Pictograms at page 39  
Pictogrammes page 39



**Contenitori da interno**  
**Indoor wastebins**  
**Poubelles pour intérieur**



**Cover superiore in metallo verniciato a polveri epossidiche.**

Metal upper cover painted with epoxy powder.

Couvercle supérieur en metal verni avec poudres epoxydes.

**Inserimento sacchetto tramite anello reggi sacco con profilo in tecnopolimero ad alta resistenza.**

Bag holder to put in and out trash with high resistant plastic contour. Anneau support sac pour mettre ou enlever les déchets avec profil en plastique en haute résistance.



**Pittogramma magnetico**  
magnetic pictogram  
pictogram magnétique.



**Fusto in metallo verniciato a polveri epossidiche.**  
Metal body painted with epoxy powder.  
Corp en metal verni avec poudres epoxydes.

**Fondo in metallo con bordino salva pavimento.**  
Metal bottom with floor-saving ring.  
Base en métal avec anneau sauve sol.

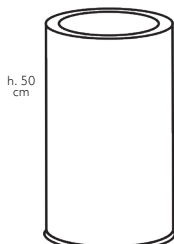

h, 50 cm

Ø 35 cm

**851** 50L

Ø 35 x h50 cm, 4,1 kg

Elegante e funzionale contenitore per raccolta rifiuti, cover a uno scomparto, realizzato totalmente in acciaio e verniciato con vernici termoindurenti.

Pratico reggisacchetto interno con svuotamento dall'alto.

*Elegant and functional wastebin with one single compartment, completely made of steel. Practical inner bag holder, emptying bag from the top.*

*Poubelle à un compartiment élégante et fonctionnelle, produite entièrement en acier. Support-sac et couvercle pratiques, avec vidage par le haut.*

**871 G**  
Acciaio verniciato grigio  
Grey painted steel  
Acier poudré gris

**871 N**  
Acciaio verniciato nero  
Black painted steel  
Acier poudré noir



1 pictogramma incluso  
1 pictogram included  
1 pictogramme inclus



Pictogrammi a pagina 39  
Pictograms at page 39  
Pictogrammes page 39



**Contenitori da interno**  
**Indoor wastebins**  
**Poubelles pour intérieur**

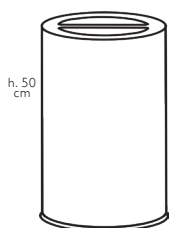
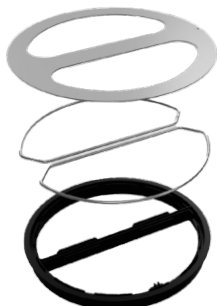

h. 50  
cm

Ø 35 cm

**852** 25L + 25L = 50L

Ø 35 x h50 cm, 4,1 kg

Elegante e funzionale contenitore per raccolta rifiuti, cover a due scomparti, realizzato totalmente in acciaio e verniciato con vernici termoindurenti.

Pratico reggisacco interno con svuotamento dall'alto.

*Elegant and functional wastebin with two compartments, completely made of steel. Practical inner bag holder, emptying bag from the top.*

*Poubelle à deux compartiments élégante et fonctionnelle, produite entièrement en acier. Support-sac et couvercle pratiques, avec vidage par le haut.*



**852 N**

Acciaio verniciato nero  
Black painted steel  
Acier peint noir

**852 G**

Acciaio verniciato grigio  
Grey painted steel  
Acier peint gris

4 pictogrammi inclusi  
4 pictograms included  
4 pictogrammes inclus

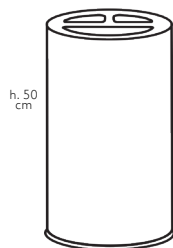

h. 50  
cm

Ø 35 cm

**853** 10L + 10L + 30L = 50L

Ø 35 x h50 cm, 4,1 kg

Elegante e funzionale contenitore per raccolta rifiuti, cover a tre scomparti, realizzato totalmente in acciaio e verniciato con vernici termoindurenti.

Pratico reggisacco interno con svuotamento dall'alto.

*Elegant and functional wastebin with three compartments, completely made of steel. Practical inner bag holder, emptying bag from the top.*

*Poubelle à trois compartiments élégante et fonctionnelle, produite entièrement en acier. Support-sac et couvercle pratiques, avec vidage par le haut.*



**853 N**

Acciaio verniciato nero  
Black painted steel  
Acier peint noir

**853 G**

Acciaio verniciato grigio  
Grey painted steel  
Acier peint gris

4 pictogrammi inclusi  
4 pictograms included  
4 pictogrammes inclus

## **Pittogrammi magnetici rettangolari 13 x h. 17 cm**

Rectangular magnetic pictograms 13 x h. 17 cm

Pictogrammes magnetiques rectangulaires 13 x h. 17 cm



Carta  
Paper  
Papier

**cod. RT-01**



Plastica  
Plastic  
Plastique

**cod. RT-02**



Organico  
Organic  
Biodéchet

**cod. RT-03**



Vetro  
Glass  
Verre

**cod. RT-04**



Indifferenziato  
General waste  
Non recyclable

**cod. RT-05**

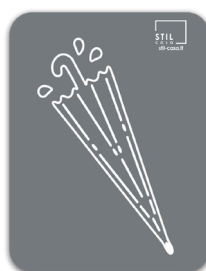

Porta ombrelli  
Umbrella stand  
Porte parapluie

**cod. RT-06**



Posacenere  
Ashtray  
Cendrier

**cod. RT-07**



Toner  
Toner  
Toner

**cod. RT-08**



Mascherina  
Mask  
Masque

**cod. RT-09**



**Pittogrammi magnetici rettangolari 13 x h. 23 cm - per art. 747 / 746**

Rectangular magnetic pictograms 13 x h. 23 cm - for article code 747 / 746

Pictogrammes magnetiques rectangulaires 13 x h. 23 cm - pour article code 747 / 746



Carta  
Paper  
Papier

**cod. RL-01**



Plastica  
Plastic  
Plastique

**cod. RL-02**



Organico  
Organic  
Biodéchet

**cod. RL-03**



Vetro  
Glass  
Verre

**cod. RL-04**



Indifferenziato  
General waste  
Non recyclable

**cod. RL-05**



Toner  
Toner  
Toner

**cod. RL-08**



Mascherina  
Mask  
Masque

**cod. RL-09**

**Pittogrammi magnetici tondi Ø 17 cm**

Round magnetic pictograms Ø 17 cm

Pictogrammes magnetiques rondes Ø 17 cm



Carta  
Paper  
Papier

**cod. TO-01**



Plastica  
Plastic  
Plastique

**cod. TO-02**



Organico  
Organic  
Biodéchet

**cod. TO-03**



Vetro  
Glass  
Verre

**cod. TO-04**



Indifferenziato  
General waste  
Non recyclable

**cod. TO-05**



Toner  
Toner  
Toner

**cod. TO-08**



Mascherina  
Mask  
Masque

**cod. TO-09**





Contenitori da interno  
Indoor wastebins  
Poubelles pour intérieur



# GASTRO

HACCP COMPATIBLE





## COMPOSIZIONE

Composition  
 Composition



**Coperchio in plastica grigio.**  
**Elastico ferma sacco. Profilo interno**  
**in tecnopolimero ad alta resistenza.**  
**Maniglia in tecnopolimero grigio.**

Grey plastic lid.  
 Bag holder elastic. High resistant inner  
 contour.  
 Grey painted tecnopolymer handle.

Couvercle en plastique grise.  
 Elastique ferme sac.  
 Profil intérieur en plastique à haute  
 résistance.  
 Poignée en tecnopolymère grise.



**BI**

**Fusto e placca superiore del coper-**  
**chio in metallo verniciato a polveri**  
**epossidiche bianche.**

White metal painted body and upper lid's  
 plate.  
 Corp et plaque supérieure du couvercle  
 en metal poudré blanc.

**A**

**Fusto e placca superiore del coper-**  
**chio in acciaio inox aisi 430 lucido a**  
**specchio.**

Aisi 430 shiny stainless steel body and  
 upper lid's plate.  
 Corp et plaque supérieure du couvercle  
 en acier inox brillant.



**Fondo in tecnopolimero ad alta resistenza.**  
**Pedale e piedi posteriori d'appoggio in**  
**tubolare di metallo verniciato grigio.**  
**Ruote in plastica con perni.**

High resistance plastic lower base.  
 Grey metal painted pedal and rear feet's  
 support.  
 Plastic wheels with hubs

Base en plastique à haute résistance.  
 Pédale et support postérieur en poudré gris.  
 Roues en plastique avec pivots.

## SVUOTAMENTO SACCHETTO

Trash bag emptying  
 Vidage du sachet





**Contenitori da interno**  
**Indoor wastebins**  
**Poubelles pour intérieur**



Pittogrammi a pagina 20  
 Pictograms at page 20  
 Pictogrammes à la page 20



**748** 

47 x 37 x h96 cm, 13 kg

Elegante e funzionale contenitore per raccolta rifiuti, realizzato totalmente in acciaio.

Svuotamento frontale.

*Elegant and functional waste bin, completely made of steel. Frontal bag emptying.*

*Poubelle élégante et fonctionnelle, produite entièrement en acier. Vidage sac frontal.*

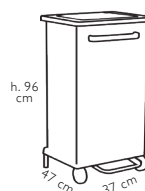

**748 B/110**

Acciaio verniciato bianco  
 White painted steel  
 Acier poudré blanc

**748 A/110**

Acciaio inox aisi 430 lucido a specchio  
 Aisi 430 shiny stainless steel  
 Acier inox brillant aisi 430

 **HACCP COMPATIBLE**



**Contenitori da interno**  
**Indoor wastebins**  
**Poubelles pour intérieur**



**749** 

47 x 37 x h83 cm, 12 kg

Elegante e funzionale contenitore per raccolta rifiuti, realizzato totalmente in acciaio.  
Svuotamento frontale.

*Elegant and functional waste bin, completely made of steel. Frontal bag emptying.*

*Poubelle élégante et fonctionnelle, produite entièrement en acier. Vidage sac frontal.*

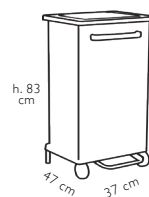

**749 B/90**

Acciaio verniciato bianco  
White painted steel  
Acier poudré blanc

**749 A/90**

Acciaio inox aisi 430 lucido a specchio  
Aisi 430 shiny stainless steel  
Acier inox brillant aisi 430



**750** 

47 x 37 x h70 cm, 11 kg

Elegante e funzionale contenitore per raccolta rifiuti, realizzato totalmente in acciaio.  
Svuotamento frontale.

*Elegant and functional waste bin, completely made of steel. Frontal bag emptying.*

*Poubelle élégante et fonctionnelle, produite entièrement en acier. Vidage sac frontal.*

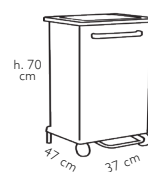

**750 B/70**

Acciaio verniciato bianco  
White painted steel  
Acier poudré blanc

**750 A/70**

Acciaio inox aisi 430 lucido a specchio  
Aisi 430 shiny stainless steel  
Acier inox brillant aisi 430





**Contenitori da interno**  
**Indoor wastebins**  
**Poubelles pour intérieur**



**406** 

54,6 x 60 x h94 cm, 10 kg

Elegante e funzionale reggisacco per raccolta rifiuti, realizzato totalmente in acciaio.

*Elegant and functional bag holder, completely made of steel.*

*Support-sac élégant et fonctionnel, produite entièrement en acier.*

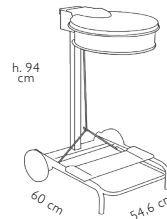

**406 A**

Acciaio inox aisi 304 satinato  
Aisi 304 brushed stainless steel  
Acier inox brossé aisi 304

**ADESIVI RACCOLTA DIFFERENZIATA**

*Stickers for separate collection*  
*Autocollants pour le tri sélectif*



**ADE406-R ADE406-VE ADE406-BL ADE406-YE**



**406** 

54,6 x 60 x h94 cm, 10 kg

Elegante e funzionale reggisacco per raccolta rifiuti, realizzato totalmente in acciaio.

*Elegant and functional bag holder, completely made of steel.*

*Support-sac élégant et fonctionnel, produite entièrement en acier.*

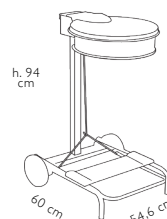

**406 BI**

Acciaio verniciato bianco  
White painted steel  
Acier poudré blanc

**ADESIVI RACCOLTA DIFFERENZIATA**

*Stickers for separate collection*  
*Autocollants pour le tri sélectif*



**ADE406-R ADE406-VE ADE406-BL ADE406-YE**





**Contenitori da interno**  
**Indoor wastebins**  
**Poubelles pour intérieur**



**406 MU**

50 x Ø 41 x Ø 38 cm, 2,6 kg

Reggisacco con coperchio per raccolta rifiuti, realizzato in acciaio. Elastico ferma sacco.

*Bag holder with lid, made of steel.*

*Bag stopper rubber.*

*Support-sac avec couvercle, produite en acier.*

*Elastique ferme sac.*

**Viti non incluse.**

Screws not included.  
Vis pas comprises.



**406 MU**

Acciaio verniciato grigio  
Grey painted steel  
Acier poudré gris



**406 SC-MU**

Ø 38 cm, 1,6 kg

Anello reggisacco per raccolta rifiuti, realizzato in acciaio. Elastico ferma sacco.

*Bag holder ring, made of steel. With bag stopper rubber.*

*Anneau support-sac, produite en acier.*

*Elastique ferme sac.*

**Viti non incluse.**

Screws not included.  
Vis pas comprises.



**406 SC-MU**

Acciaio verniciato grigio  
Grey painted steel  
Acier poudré gris

da interno in cartone  
in wastebins  
sur intérieur en carton



# REWASTE



## COMPOSIZIONE

Composition  
Composition



Coperchio superiore in tecnopolimero 100% ricic-  
lato nero.  
Kit 4 adesivi colorati inclusi.

100% recycled black tecnopolymer upper cover:  
4 colored stickers included.

Couvercle supérieur en tecnopolymèr  
100% recyclé.  
Kit 4 autocollants inclus.



Fusto in cartone 70% riciclato  
spessore 7 mm.  
Stampa digitale eseguita sul cartone.

70% recycled carton body, 7 mm  
depth. Carton digitally printed.

Corps en carton 70% recyclé, épais-  
seur 7 mm.  
Impression digitale directement sur  
le carton.



Fondo in metallo verniciato nero.  
Piedi in gomma antigraffio.

Black metal painted bottom.  
Scratchproof rubber lower feet.

Base en métal poudré noir.  
Pieds anti-rayures en gomme.



**Contenitori da interno in cartone**  
**Indoor carton wastebins**  
**Poubelles pour intérieur en carton**



Kit 4 adesivi inclusi  
 4 stickers included  
 Kit 4 autocollants inclus

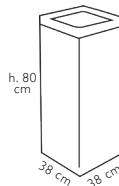

**PUC100** <sup>100L</sup>

38 x 38 x h80 cm, 3,3 kg

Contenitore per raccolta rifiuti realizzato in cartone stampato spessore 7 mm. Cover superiore in plastica 100% riciclata. Adesivi colorati inclusi.

*Printed 7 mm carton wastebbin. 100% recycled plastic upper cover. Colored stickers included.*

*Poubelle en carton imprimé, épaisseur 7 mm. Couvercle supérieure en plastique 100% recyclé. Autocollants inclus.*



**PUC100-N**  
 Simbolo rifiuti misti  
 General waste symbol  
 Symbol mixte



**PUC100-YE**  
 Simbolo plastica  
 Plastic symbol  
 Symbol plastique



**PUC100-BL**  
 Simbolo carta  
 Paper symbol  
 Symbol papier



**PUC100-R**  
 Simbolo organico  
 Organic symbol  
 Symbol organique



**PUC100-VE**  
 Simbolo vetro  
 Glass symbol  
 Symbol verre



**PUC100-G01**  
 Grafica maiolica  
 Majolica graphic  
 Graphique majolique



**PUC100-G02**  
 Grafica bosco  
 Forest graphic  
 Forete graphique

**Ricambio fusto cartone**

Carton body replacement  
 Rechange corps en carton

**RIC100-MI**



**RIC100-PL**



**RIC100-CA**



**RIC100-OR**



**RIC100-VE**



**RIC100-G1**



**RIC100-G2**



**Ricambio cover + base + kit adesivi**

Cover + bottom replacement + sticker kit  
 Rechange base + couvercle + kit autocollants



**CF-100**



Kit 4 adesivi inclusi  
 4 stickers included  
 Kit 4 autocollants inclus

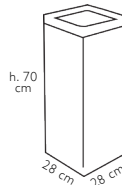

**PUC60** <sup>60L</sup>

28 x 28 x h70 cm, 2,1 kg

Contenitore per raccolta rifiuti realizzato in cartone stampato spessore 7 mm. Cover superiore in plastica 100% riciclata. Adesivi colorati inclusi.

*Printed 7 mm carton wastebbin. 100% recycled plastic upper cover. Colored stickers included.*

*Poubelle en carton imprimé, épaisseur 7 mm. Couvercle supérieure en plastique 100% recyclé. Autocollants inclus.*



**PUC60-N**  
 Simbolo rifiuti misti  
 General waste symbol  
 Symbol mixte



**PUC60-YE**  
 Simbolo plastica  
 Plastic symbol  
 Symbol plastique



**PUC60-BL**  
 Simbolo carta  
 Paper symbol  
 Symbol papier



**PUC60-R**  
 Simbolo organico  
 Organic symbol  
 Symbol organique



**PUC60-VE**  
 Simbolo vetro  
 Glass symbol  
 Symbol verre



**PUC60-G01**  
 Grafica maiolica  
 Majolica graphic  
 Graphique majolique



**PUC60-G02**  
 Grafica bosco  
 Forest graphic  
 Forete graphique

**Ricambio fusto cartone**

Carton body replacement  
 Rechange corps en carton

**RIC60-MI**



**RIC60-PL**



**RIC60-CA**



**RIC60-OR**



**RIC60-VE**



**RIC60-G1**



**RIC60-G2**



**Ricambio cover + base + kit adesivi**

Cover + bottom replacement + sticker kit  
 Rechange base + couvercle + kit autocollants



**CF-60**





## COMPOSIZIONE

Composition  
 Composition



Coperchio superiore in metallo verniciato nero.

Black metal painted upper cover:

Couvercle en métal poudré noir:



Fusto in cartone 70% riciclato spessore 7 mm.

Stampa digitale eseguita sul cartone.

70% recycled carton body, 7 mm depth. Carton digitally printed.

Corps en carton 70% recyclé, épaisseur 7 mm. Impression digitale directement sur le carton.



Fondo in metallo verniciato nero. Piedi in gomma antigraffio.

Black metal painted bottom. Scratchproof rubber lower feet.

Base en métal poudré noir: Pieds anti-rayures en gomme.

**PUC100-PBG**



38 x 38 x h80 cm, 3,3 kg



Ø 10,5 cm

Bicchieri in plastica  
 Plastic cups  
 Verre en plastique



**PUC100-PBC**



38 x 38 x h80 cm, 3,3 kg



Ø 7,5 cm

Bicchierini caffè  
 Coffee cups  
 Gobelet à café



**PUC60-PBC**



28 x 28 x h70 cm, 2,1 kg



Ø 7,5 cm

Bicchierini caffè  
 Coffee cups  
 Gobelet à café





Contenitori da interno in cartone  
Indoor carton wastebins  
Poubelles pour intérieur en carton



## PERSONALIZZAZIONE

Customization

Personnalisation

Puoi personalizzare il fusto del contenitore secondo le tue necessità, grazie alla stampa digitale eseguita direttamente sul cartone.

Minimo di stampa: 32 pezzi.

Invia il file in formato vettoriale a [grafica@stil-casa.it](mailto:grafica@stil-casa.it) e riceverai una bozza di prova da confermare.

Thanks to the direct digital print on carton, you can customize the bin body based on your necessities.

Order minimum: 32 pieces.

Send the vectorial file to [grafica@stil-casa.it](mailto:grafica@stil-casa.it) and you'll receive the draft to be approved.

Vous pouvez personnaliser le corps de la poubelle selon vos besoins, grâce à l'impression digitale directe sur le carton.

Minimum de commande: 32 pièces.

Vous pouvez envoyer le file en format vectorial à [grafica@stil-casa.it](mailto:grafica@stil-casa.it) et une bon à tirer sera envoyé pour approvation finale.



### ISTRUZIONI DI MONTAGGIO / ASSEMBLY INSTRUCTIONS / INSTRUCTIONS D'ASSEMBLAGE / MONTAGEANLEITUNG

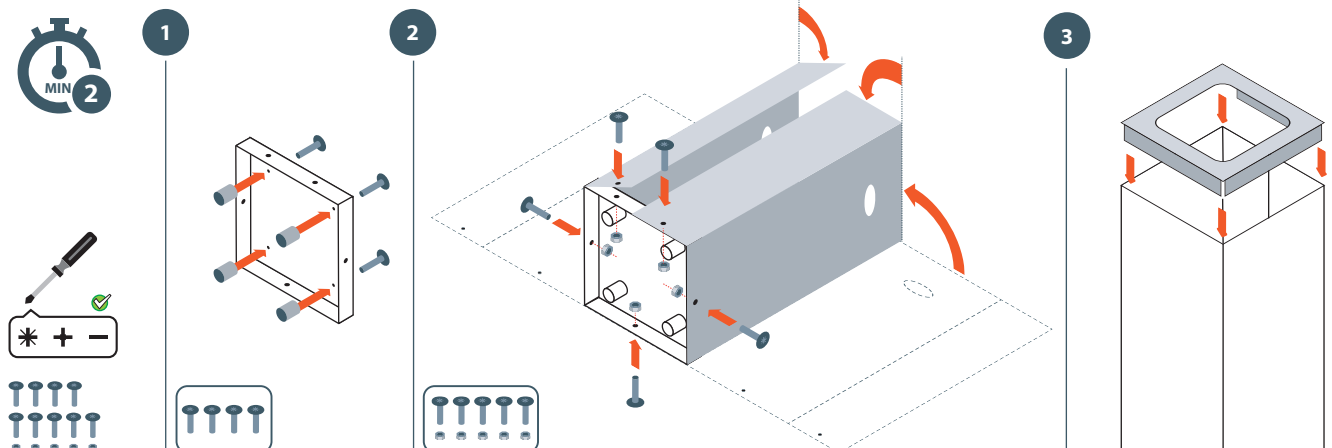



Contenitori da esterno  
Outdoor wastebins  
Poubelles pour extérieur



**NEW**

# MODULA

OUTDOOR





## COMPOSIZIONE

Composition  
 Composition

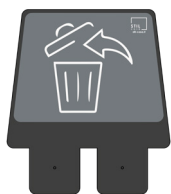

**Pannello stampato in PVC spessore 5 mm.**  
 PVC 5 mm printed panel.  
 Panneau en PVC 5 mm imprimé.



**Anello e colonna di supporto in acciaio verniciato grigio.**  
 Black painted steel ring and column support.  
 Anneau et poteau de support en acier poudré gris.

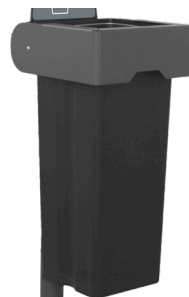

**Per versione con secchio: contenitore interno in plastica nero da 50 litri.**  
 For the bucket version: inner 50 liters black plastic container:  
 Pour la version avec seau: conteneur interne en plastique, capacité 50 litres.

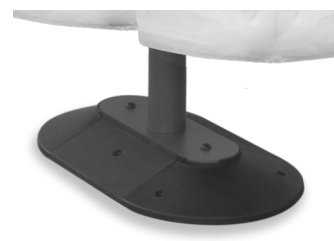

**Base in tecnopolimero ad alta resistenza con zavorra in metallo.**  
 High resistance tecnopolymer base with metal bottom.  
 Base en tecnopolymère haute résistance avec ballast en métal.

## ESTRAZIONE CONTENITORE IN PLASTICA

Easy inner plastic bucket removal  
 Extraction facilitée du conteneur en plastique

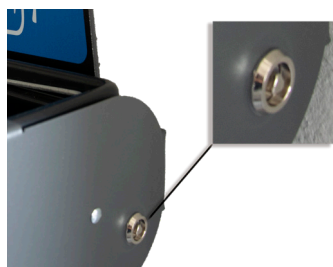

## INSERIMENTO SACCHETTO

Trash bag insertion  
 Insertion sachet





**Contenitori da esterno**  
**Outdoor wastebins**  
**Poubelles pour extérieur**

**NEW**



**MOD-4**



78,5 x 85 x h114,5 cm, 10 kg

Elegante e funzionale reggisacco per raccolta rifiuti, realizzato totalmente in acciaio.

*Elegant and functional bag holder, completely made of steel.*

*Support-sac élégant et fonctionnel, produite entièrement en acier.*

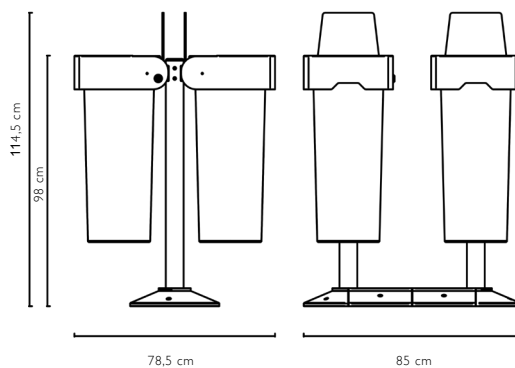

**PANNELLI INCLUSI**  
**Included panles**  
**Panneaux inclus**

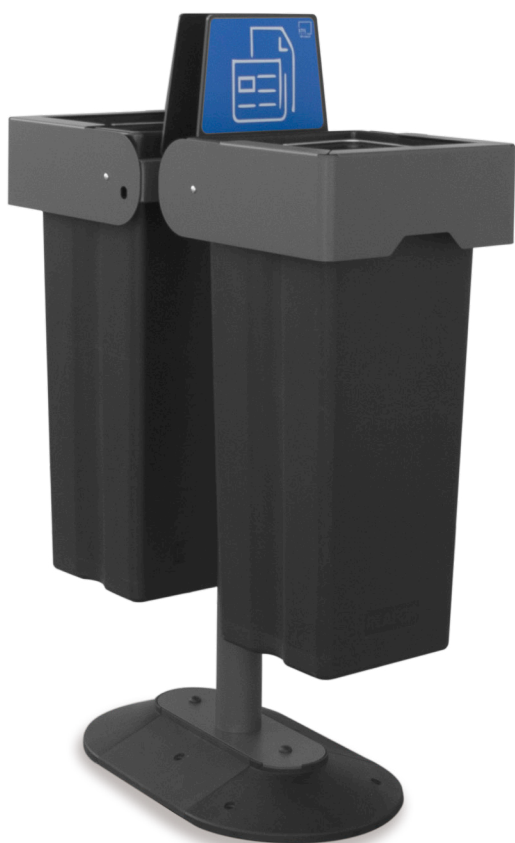
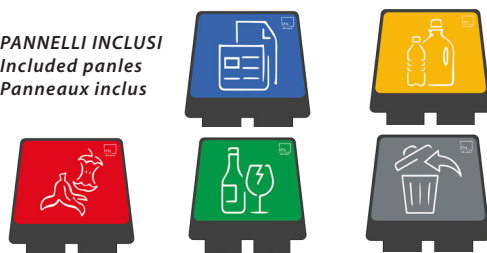

**MOD-2**



78,5 x 85 x h114,5 cm, 10 kg

Elegante e funzionale reggisacco per raccolta rifiuti, realizzato totalmente in acciaio.

*Elegant and functional bag holder, completely made of steel.*

*Support-sac élégant et fonctionnel, produite entièrement en acier.*

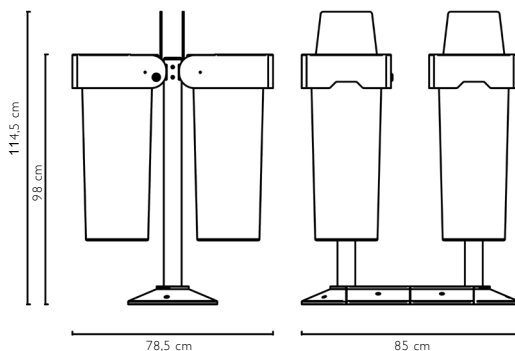

**PANNELLI INCLUSI**  
**Included panles**  
**Panneaux inclus**

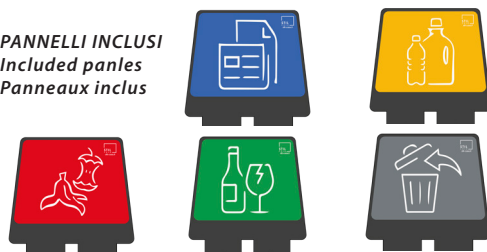



**Contenitori da esterno**  
**Outdoor wastebins**  
**Poubelles pour extérieur**

**NEW**

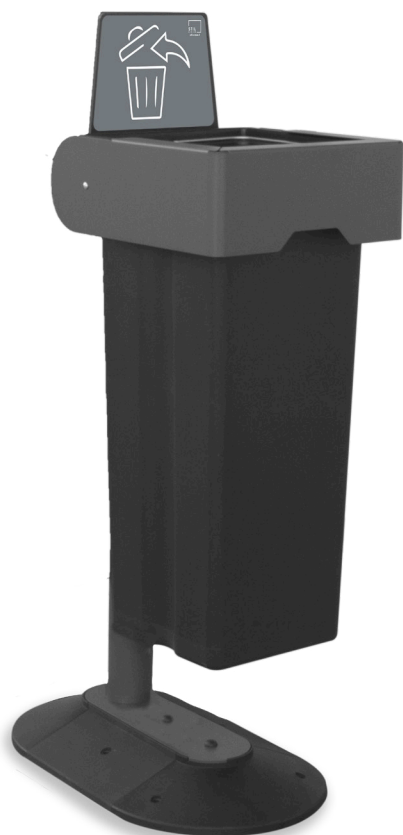

1 pannello incluso  
 1 panel included  
 1 panneau inclus

**MOD-1**



35 x 60 x h114,5 cm, 10 kg

Elegante e funzionale reggisacchetto per raccolta rifiuti, realizzato totalmente in acciaio.

*Elegant and functional bag holder, completely made of steel.*

*Support-sac élégant et fonctionnel, produite entièrement en acier.*

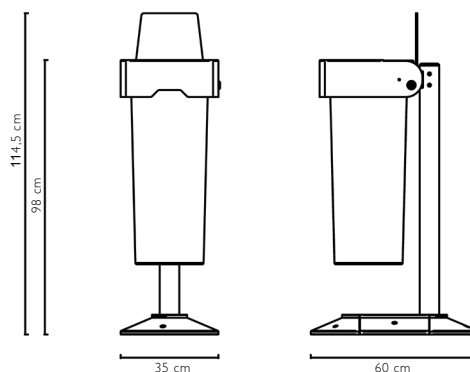

**ALTRI PANNELLI DISPONIBILI**

*Other available panels*

*Autres panneaux disponibles*



**MP-01**



**MP-02**



**MP-03**



**MP-04**



1 pannello incluso  
 1 panel included  
 1 panneau inclus

**MOD-MU**



35 x 37 x h114,5 cm, 10 kg

Elegante e funzionale reggisacchetto per raccolta rifiuti, realizzato totalmente in acciaio.

*Elegant and functional bag holder, completely made of steel.*

*Support-sac élégant et fonctionnel, produite entièrement en acier.*

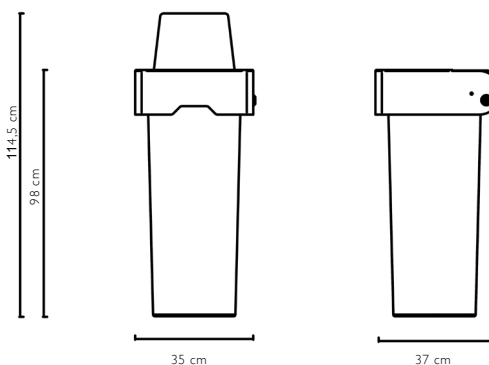

**ALTRI PANNELLI DISPONIBILI**

*Other available panels*

*Autres panneaux disponibles*



**MP-01**



**MP-02**



**MP-03**



**MP-04**



**Contenitori da esterno**  
**Outdoor wastebins**  
**Poubelles pour extérieur**

**NEW**



110L

**MOD-SC-4**

78,5 x 85 x h114,5 cm, 10 kg

Elegante e funzionale reggisacco per raccolta rifiuti, realizzato totalmente in acciaio.

*Elegant and functional bag holder, completely made of steel.*

*Support-sac élégant et fonctionnel, produite entièrement en acier.*



Sacco non incluso  
 Plastic bag not included  
 Sachtet pas inclus

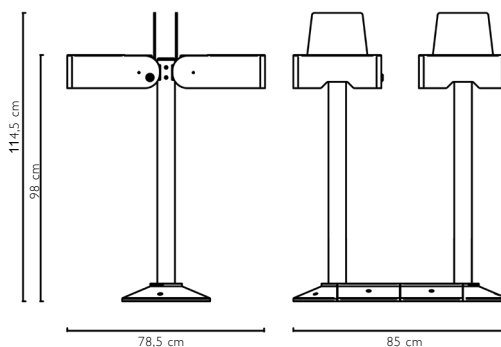

**PANNELLI INCLUSI**  
 Included panles  
 Panneaux inclus



**MOD-SC-2**

110L

78,5 x 85 x h114,5 cm, 10 kg

Elegante e funzionale reggisacco per raccolta rifiuti, realizzato totalmente in acciaio.

*Elegant and functional bag holder, completely made of steel.*

*Support-sac élégant et fonctionnel, produite entièrement en acier.*



Sacco non incluso  
 Plastic bag not included  
 Sachtet pas inclus

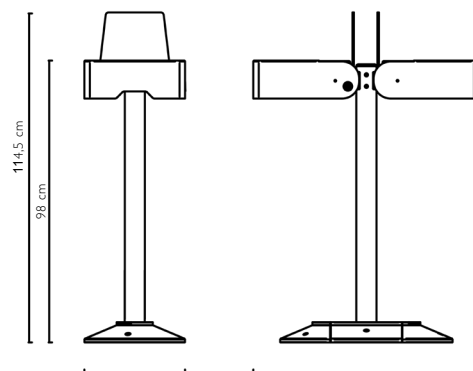

78,5 cm  
**PANNELLI INCLUSI**  
 Included panles  
 Panneaux inclus

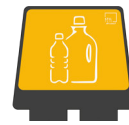



**Contenitori da esterno**  
**Outdoor wastebins**  
**Poubelles pour extérieur**

**NEW**



1 pannello incluso  
1 panel included  
1 panneau inclus

Sacco non incluso  
Plastic bag not included  
Sachet pas inclus

**MOD-SC-1**



57 x 35 x h114,5 cm, 10 kg

Elegante e funzionale reggisacco per raccolta rifiuti, realizzato totalmente in acciaio.

*Elegant and functional bag holder, completely made of steel.*

*Support-sac élégant et fonctionnel, produite entièrement en acier.*

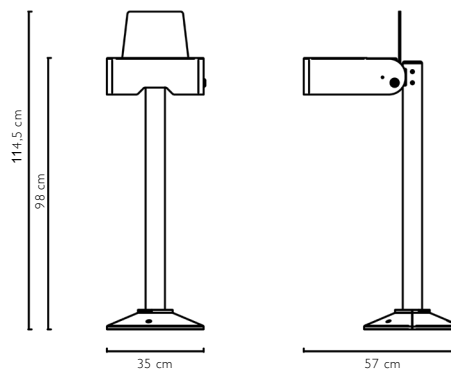

**ALTRI PANNELLI DISPONIBILI**

*Other available panels*

*Autres panneaux disponibles*



**MP-01**



**MP-02**



**MP-03**



**MP-04**



1 pannello incluso  
1 panel included  
1 panneau inclus

Sacco non incluso  
Plastic bag not included  
Sachet pas inclus

**MOD-SC-MU**



35 x 37 x h30 cm, 10 kg

Elegante e funzionale reggisacco per raccolta rifiuti, realizzato totalmente in acciaio.

*Elegant and functional bag holder, completely made of steel.*

*Support-sac élégant et fonctionnel, produite entièrement en acier.*

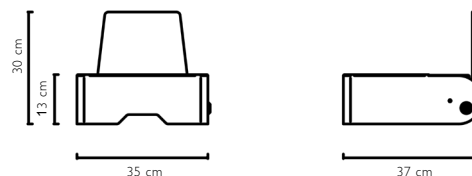

**ALTRI PANNELLI DISPONIBILI**

*Other available panels*

*Autres panneaux disponibles*



**MP-01**



**MP-02**



**MP-03**



**MP-04**





Posacenere da esterno  
Outdoor ashtray  
Cendrier pour extérieur



**Testa e griglia spegni sigarette removibili, apertura e chiusura con serratura.**

Upper part and metal grill to put out cigarettes, opening and closing with security lock.

Tête et grille pour éteindre la cigarette, ouverture et fermeture avec serrure.



**Raccogliatore estraibile in banda stagnata 2L.**

Inner tinplate 2 L container.

Conteneur en fer-blanc 2 litres.



**Colonna e base con predisposizione per fissaggio a terra, in metallo verniciato a polveri epossidiche.** / Epoxy powder metal painted column and base with ground fixing predisposition. / Poteau et base avec prédisposition pour fixation au sol, en métal verni à poudre époxyde.



**Modello disponibile anche per fissaggio a parete.** Wall fixing model available too. Modél disponible aussi pour fixation au mur.



**Posacenere da esterno**  
**Outdoor ashtray**  
**Cendrier pour extérieur**

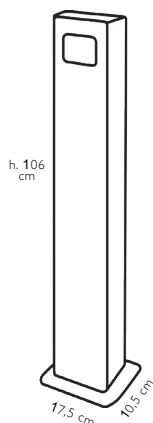

**PTE**

17,5 x 10,5 x h106 cm, 5 kg

Posacenere da terra con predisposizione per fissaggio al suolo in acciaio verniciato.

*Painted steel column ashtray with ground fixing predisposition.*

*Cendrier en acier poudré avec prédisposition pour fixation au sol.*

**PTE-C**

Acciaio verniciato corten  
Corten painted steel  
Acier poudré corten

**PTE-N**

Acciaio verniciato nero  
Black painted steel  
Acier poudré noir

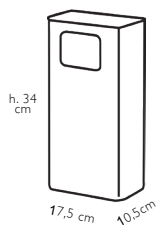

**PME**

17,5 x 10,5 x h34 cm, 3 kg

Posacenere da muro con predisposizione per fissaggio a parete in acciaio verniciato.

*Painted steel ashtray with wall fixing predisposition.*

*Cendrier en acier poudré avec prédisposition pour fixation au mur.*

**PME-C**

Acciaio verniciato corten  
Corten painted steel  
Acier poudré corten

**PME-N**

Acciaio verniciato nero  
Black painted steel  
Acier poudré noir



**Posacenere da esterno**  
**Outdoor ashtray**  
**Cendrier pour extérieur**

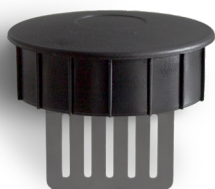

**Testa e griglia spegni sigarette removibili, apertura e chiusura con serratura.**

Upper part and metal grill to put out cigarettes, opening and closing with security lock.

Tête et grille pour éteindre la cigarette, ouverture et fermeture avec serrure.



**Raccoglitore estraibile in banda stagnata 3L.**

Inner tinplate 3 L container.

Conteneur en fer-blanc 3 litres.



**Colonna in alluminio verniciato o satinato**

Painted or glazed aluminum column.

Poteau en aluminium verni ou brossé.

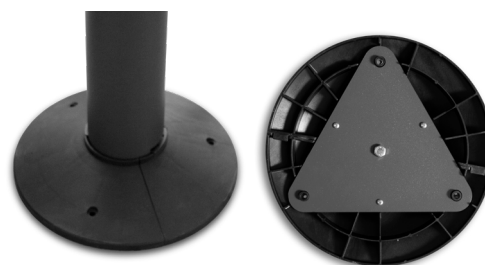

**Copertura base in plastica ad alta resistenza, con possibilità di fissaggio a terra. Zavorra in metallo.**

High resistance plastic base cover, with ground fixing possibility. Metal ballast.

Base de couverture en plastique à haute résistance, avec possibilité de fixation au sol. Ballast en métal.



**Posacenere da esterno**  
**Outdoor ashtray**  
**Cendrier pour extérieur**

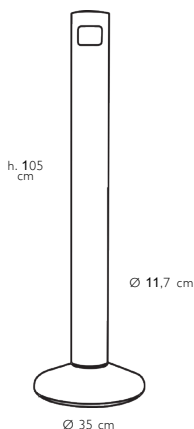

### 701

Ø 35 x Ø 11,7 x h105 cm, 6 kg

Posacenere da terra con predisposizione per fissaggio al suolo in alluminio verniciato.

*Painted aluminum column ashtray with ground fixing predisposition.*

*Cendrier en aluminium poudré avec prédisposition pour fixation au sol.*

#### 701 C

Colonna in alluminio verniciato corten, base in plastica nera  
Corten painted aluminum column, black plastic base  
Poteau en aluminium poudré corten, base en plastique noire

#### 701 N

Colonna in alluminio verniciato nero, base in plastica nera  
Black painted aluminum column, black plastic base  
Poteau en aluminium poudré noir, base en plastique noire

#### 701 AS

Colonna in alluminio verniciato inox satinato, base in plastica nera  
Brushed painted aluminum column, black plastic base  
Poteau en aluminium poudré brossé, base en plastique noire

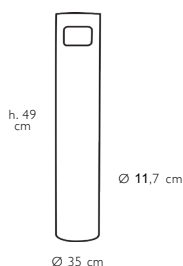

### 700

Ø 35 x Ø 11,7 x h49 cm, 3,5 kg

Posacenere da muro con predisposizione per fissaggio a parete in alluminio verniciato.

*Painted aluminum ashtray with wall fixing predisposition.*

*Cendrier en aluminium poudré avec prédisposition pour fixation au mur.*

#### 700 C

Alluminio verniciato corten  
Corten painted aluminum  
Alluminium poudré corten

#### 700 N

Alluminio verniciato nero  
Black painted aluminum  
Alluminium poudré noir

#### 700 AS

Alluminio verniciato inox satinato  
Brushed painted aluminum  
Alluminium poudré brossé



**Gettacarte con posacenere per esterno coperto**  
**Covered outdoor wastebin with ashtray**  
**Poubelle avec cendrier pour extérieur couvert**



**Ghiera superiore spegni sigarette in metallo verniciato.**

Metal painted upper grill to put out cigarettes.

Grille supérieure en métal verni pour éteindre les cigarettes.



**Vaschetta interna in metallo verniciato estraibile - capienza 1,5 litri.**

Metal painted extractable inner tank - capacity 1,5 liters.

Bac intérieure amovible en métal verni - capacité 1,5 litres.



**Base in metallo verniciato con predisposizione per fissaggio a parete.**

Metal painted base with wall fixing predisposition.

Base en métal verni avec prédisposition pour fixation au mur.

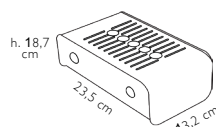

**551**

23,5 x 13,2 x h18,7 cm, 1,5 kg

Posacenere con predisposizione per fissaggio a parete in acciaio verniciato.

*Painted steel ashtray with wall fixing predisposition.*

*Cendrier en acier poudré avec prédisposition pour fixage au mur.*

**551 N**

Acciaio verniciato nero.  
Black painted steel.  
Acier poudré noir.

**540**

Ø 31 x h72 cm, 5,5 kg

Posacenere da terra in acciaio verniciato. 1 kg di sabbia incluso. Anello in plastica antigraffio.

*Painted steel ashtray, 1 kg of sand included. Scratch-proof lower plastic ring.*

*Cendrier en acier poudré. 1 kg de sand inclus. Anneau anti-rayures en plastique.*

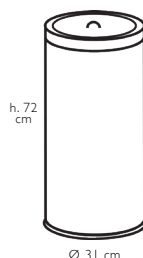

**540 G**

Acciaio verniciato grigio, cover in acciaio nera.  
Grey painted steel, black painted steel cover.  
Acier poudré gris, couvercle en acier

**540 N**

Acciaio verniciato nero, cover nera.  
Black painted steel, black painted steel cover.  
Acier poudré noir, couvercle en acier noir.

**540 AS**

Acciaio inox satinato, cover in acciaio nero.  
Brushed stainless steel, black painted steel cover.  
Acier inox brossé, couvercle en acier noir.



**Posacenere per esterno coperto**  
**Covered outdoor ashtray**  
**Cendrier pour extérieur couvert**

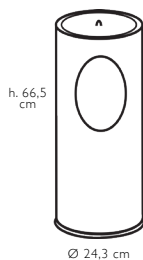

**584** 

Ø 24,3 x h66,5 cm, 3,7 kg

Gettacarta con posacenere in acciaio verniciato. 1 kg di sabbia incluso. Anello in plastica antigraffio.

*Painted steel wastebin with ashtray, 1 kg of sand included. Scratchproof lower plastic ring.*

*Poubelle avec cendrier en acier peint. 1 kg de sable inclus. Anneau anti-rayures en plastique.*

**584 G**

Acciaio verniciato grigio, cover in acciaio nero.  
Grey painted steel, black painted steel cover.  
Acier peint gris, couvercle en acier noir.

**584 N**

Acciaio verniciato nero, cover nera.  
Black painted steel, black painted steel cover.  
Acier peint noir, couvercle en acier noir.

**584 AS**

Acciaio inox satinato, cover in acciaio nero.  
Brushed stainless steel, black painted steel cover.  
Acier inox brossé, couvercle en acier noir.

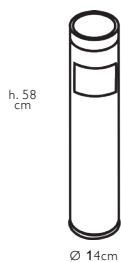

**108** 

Ø 14 x h58 cm, 1,5 kg

Gettacarta con posacenere in acciaio verniciato. Anello in plastica antigraffio.

*Painted steel wastebin with ashtray. Scratchproof lower plastic ring.*

*Poubelle avec cendrier en acier peint. Anneau anti-rayures en plastique.*

**108 G**

Acciaio verniciato grigio, posacenere nero.  
Grey painted steel, black painted steel ashtray.  
Acier peint gris, cendrier en acier noir.

**108 N**

Acciaio verniciato nero, posacenere nero.  
Black painted steel, black painted steel ashtray.  
Acier peint noir, cendrier en acier noir.



# STANDARD



Ricca gamma di prodotti per interno ed esterno coperto, adatta ad ogni esigenza di raccolta rifiuti. Gettacarta, posacenere, porta ombrelli, contenitori autoestinguenti.

Diversi utilizzi, molteplici materiali; **qualsiasi ambiente più essere valorizzato.**

*A wide range of products for indoor and covered outdoor, wastebins, umbrella stands, astrays, self-extinguish bins.*

*Many uses, many materials; **every locations can be appreciated.***

*Vaste gamme de produits pour intérieur et extérieur couvert, poubelles, cendriers, porte-parapluies, poubelles auto-extinguibles.*

*Différentes utilisations, plusieurs matériels; **tous les milieux peuvent être valorisés.***



**Cover realizzata in acciaio zincato.**

**Verniciatura a polveri epossidiche**

Galvanized steel cover. Epoxy powder painting.

Couvercle en métal galvanisé épaisseur 2 mm. Peinture à poudres époxy

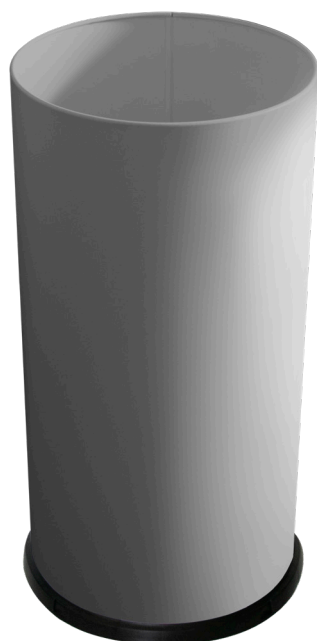

**N**

**G**

**Acciaio verniciato a polveri epossidiche.**

Epoxy powder coating steel.

Acier poudré.

**A**

**Acciaio inox lucido.**

Shiny stainless steel.

Acier inox brillant.

**AS**

**Acciaio inox satinato.**

Brushed stainless steel.

Acier inox brossé.



**Fondo in ferro zincato, anello salva pavimento in plastica.**

Metal bottom with floor-saving ring.

Base en métal avec anneau save sol.





**Gettacarte da interno**  
**Indoor wastepaper bin**  
**Poubelle pour intérieur**

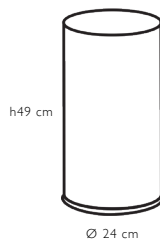

**581** 

Ø 24 x h49 cm, 2,5 kg

Portaombrelli in acciaio, con bordino salva pavimento in plastica. Vaschetta interna raccogli goccia.

*Steel umbrella stand with save floor plastic ring. Inner plastic water pan.*

*Porte parapluie en acier avec anneau en plastique sauve pavements. Bac intérieur pour contenir l'eau.*



**581 N**

Acciaio verniciato nero  
Black metal painted  
Acier poudré noir



**581 G**

Acciaio verniciato grigio  
Grey metal painted  
Acier poudré gris



**581 A**

Acciaio inox lucido  
Shiny stainless steel  
Acier inox brillant

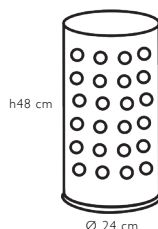

**116** 

Ø 24 x h48 cm, 1,8 kg

Portaombrelli in acciaio, con bordino salva pavimento in plastica. Vaschetta interna raccogli goccia.

*Steel umbrella stand with save floor plastic ring. Inner plastic water pan.*

*Porte parapluie en acier avec anneau en plastique sauve pavements. Bac intérieur pour contenir l'eau.*



**116 N**

Acciaio verniciato nero  
Black metal painted  
Acier poudré noir



**116 G**

Acciaio verniciato grigio  
Grey metal painted  
Acier poudré gris



**Portaombrelli  
Umbrella stand  
Porta parapluie**

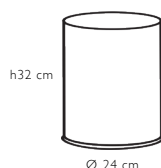

**580** 

Ø 24 x h32 cm, 1,8 kg

Elegante e funzionale sistema di raccolta rifiuti, realizzato in acciaio.

Bordino salva pavimento in plastica.

*Elegant and functional waste collection system, completely made of steel.*

*Save floor plastic ring.*

*Système pour tri sélectif élégant et fonctionnel, produit entièrement en acier. Anneau en plastique sauve pavements.*

**580 N**  
Acciaio verniciato nero  
Black metal painted  
Acier poudré noir

**580 G**  
Acciaio verniciato grigio  
Grey metal painted  
Acier poudré gris

**580 A**  
Acciaio inox lucido  
Shiny stainless steel  
Acier inox brillant

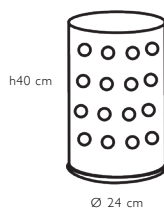

**120** 

Ø 24 x h40 cm, 1,2 kg

Elegante e funzionale sistema di raccolta rifiuti, realizzato totalmente in acciaio.

Pratico reggisacchetto interno con svuotamento dall'alto.

*Elegant and functional waste collection system, completely made of steel. Practical inner bag holder, emptying bag from the top.*

*Système pour tri sélectif élégant et fonctionnel, produit entièrement en acier. Support-sac et couvercle pratiques, avec vidage par le haut.*

**120 N**  
Acciaio verniciato nero  
Black metal painted  
Acier poudré noir

**120 G**  
Acciaio verniciato grigio  
Grey metal painted  
Acier poudré gris



**Gettacarta autoestinguente**  
**Self-extinguish waste bin**  
**Poubelle auto-extinguible**

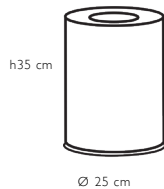

**544** 

Ø 25 x h35 cm, 1,9 kg

Gettacarta autoestinguente in acciaio, con bordino salva pavimento in plastica.

*Steel self-extinguish bin, with save floor plastic ring.*

*Poubelle auto-extinguible en acier avec anneau en plastique sauve pavements.*

**544 N**  
Acciaio verniciato nero  
Black metal painted  
Acier poudré noir

**544 G**  
Acciaio verniciato grigio  
Grey metal painted  
Acier poudré gris

**544 AS**  
Acciaio inox satinato  
Brushed stainless steel  
Acier inox brossé

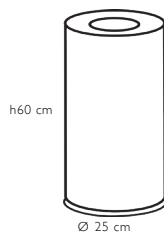

**545** 

Ø 25 x h60 cm, 2,3 kg

Gettacarta autoestinguente in acciaio, con bordino salva pavimento in plastica.

*Steel self-extinguish bin, with save floor plastic ring.*

*Poubelle auto-extinguible en acier avec anneau en plastique sauve pavements.*

**545 N**  
Acciaio verniciato nero  
Black metal painted  
Acier poudré noir

**545 G**  
Acciaio verniciato grigio  
Grey metal painted  
Acier poudré gris

**545 AS**  
Acciaio inox satinato  
Brushed stainless steel  
Acier inox brossé

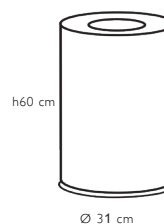

**546** 

Ø 31 x h60 cm, 2,9 kg

Gettacarta autoestinguente in acciaio, con bordino salva pavimento in plastica.

*Steel self-extinguish bin, with save floor plastic ring.*

*Poubelle auto-extinguible en acier avec anneau en plastique sauve pavements.*

**546 N**  
Acciaio verniciato nero  
Black metal painted  
Acier poudré noir

**546 G**  
Acciaio verniciato grigio  
Grey metal painted  
Acier poudré gris

**546 AS**  
Acciaio inox satinato  
Brushed stainless steel  
Acier inox brossé



**Gettacarta autoestinguente**  
**Self-extinguish waste bin**  
**Poubelle auto-extinguible**

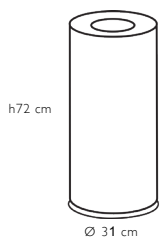

**547**

Ø 31 x h72 cm, 5,5 kg

Gettacarta autoestinguente in acciaio, con bordino salva pavimento in plastica.

*Steel self-extinguish bin, with save floor plastic ring.*

*Poubelle auto-extinguible en acier avec anneau en plastique sauve pavements.*

**547 N**  
 Acciaio verniciato nero  
 Black metal painted  
 Acier poudré noir

**547 G**  
 Acciaio verniciato grigio  
 Grey metal painted  
 Acier poudré gris

**547 AS**  
 Acciaio inox satinato  
 Brushed stainless steel  
 Acier inox brossé

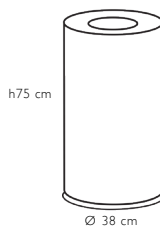

**542**

Ø 38 x h75 cm, 7,5 kg

Gettacarta autoestinguente in acciaio, con bordino salva pavimento in plastica.

*Steel self-extinguish bin, with save floor plastic ring.*

*Poubelle auto-extinguible en acier avec anneau en plastique sauve pavements.*

**542 N**  
 Acciaio verniciato nero  
 Black metal painted  
 Acier poudré noir

**542 G**  
 Acciaio verniciato grigio  
 Grey metal painted  
 Acier poudré gris

**542 AS**  
 Acciaio inox satinato  
 Brushed stainless steel  
 Acier inox brossé



**Gettacarta autoestinguente**  
**Self-extinguish waste bin**  
**Poubelle auto-extinguible**

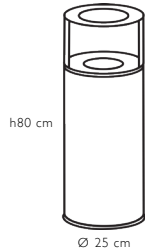

1 kg di sabbia incluso  
 1 kg of sand included  
 1 kg de sable inclus

**572**



Ø 25 x h80 cm, 4 kg

Gettacarta autoestinguente in acciaio, con testa posacenere. Bordino inferiore in plastica salva pavimento. 1 kg di sabbia incluso.

*Steel self-extinguish bin with ashtray. Save floor plastic ring. 1 kg sand included.*

*Poubelle auto-extinguible en acier avec cendrier. Anneau en plastique sauve pavements. 1 kg de sable inclus.*



**572 N**

Acciaio verniciato nero  
 Black metal painted  
 Acier peint noir



**572 G**

Acciaio verniciato grigio  
 Grey metal painted  
 Acier peint gris



**572 AS**

Fusto acciaio inox satinato, testa acciaio verniciato nero  
 Brushed stainless steel body, black metal painted upper ashtray  
 Corps en acier inox brossé, cendrier en acier peint noir

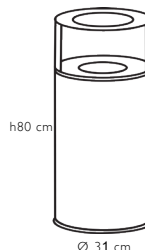

1 kg di sabbia incluso  
 1 kg of sand included  
 1 kg de sable inclus

**570**



Ø 31 x h80 cm, 7,5 kg

Gettacarta autoestinguente in acciaio, con testa posacenere. Bordino inferiore in plastica salva pavimento. 1 kg di sabbia incluso.

*Steel self-extinguish bin with ashtray. Save floor plastic ring. 1 kg sand included.*

*Poubelle auto-extinguible en acier avec cendrier. Anneau en plastique sauve pavements. 1 kg de sable inclus.*



**570 N**

Acciaio verniciato nero  
 Black metal painted  
 Acier peint noir



**570 G**

Acciaio verniciato grigio  
 Grey metal painted  
 Acier peint gris



**570 AS**

Fusto acciaio inox satinato, testa acciaio verniciato nero  
 Brushed stainless steel body, black metal painted upper ashtray  
 Corps en acier inox brossé, cendrier en acier peint noir



**Gettacarta autoestinguente**  
**Self-extinguish waste bin**  
**Poubelle auto-extinguible**

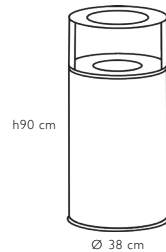

1 kg di sabbia incluso  
1 kg of sand included  
1 kg de sable inclus

**574** 

Ø 38 x h90 cm, 11 kg

Gettacarta autoestinguente in acciaio, con testa posacenere. Bordino inferiore in plastica salva pavimento. 1 kg di sabbia incluso.

*Steel self-extinguish bin with ashtray. Save floor plastic ring. 1 kg sand included.*

*Poubelle auto-extinguible en acier avec cendrier. Anneau en plastique sauve pavements. 1 kg de sable inclus.*

**574 N**

Acciaio verniciato nero  
Black metal painted  
Acier poudré noir

**574 G**

Acciaio verniciato grigio  
Grey metal painted  
Acier poudré gris

**574 AS**

Fusto acciaio inox satinato, testa acciaio verniciato nero  
Brushed stainless steel body, black metal painted upper ashtray  
Corps en acier inox brossé, cendrier en acier poudré noir





## COMPOSIZIONE

Composition  
Composition



**Maniglia posteriore per facilitare lo spostamento.**

Back handle to better allow the bin moving.

Poignée postérieure pour faciliter le déplacement de la poubelle.



**Secchio interno in plastica removibile.**

Inner removable plastic bucket.

Seau intérieur amovible en plastique.



**Apertura a pedale e bordino inferiore antigraffio.**

Pedal opening and scratchproof lower ring.

Ouverture à pédal et anneau sauve sol.



### CRP30 <sup>30L</sup>

Ø 29 x h64 cm, 3,5 kg

Gettacarta con coperchio e apertura a pedale in acciaio. Secchio interno estraibile in plastica.

*Lid with pedal opening steel wastebin.  
Inner plastic bucket.*

*Poubelle avec couvercle et ouverture à pédal.  
Seau interne en plastique.*

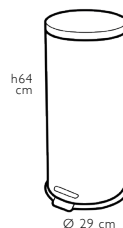

**CRP30 B**  
Acciaio verniciato bianco  
White metal painted  
Acier poudré blanc

**CRP30 A**  
Acciaio inox lucido  
Shiny stainless steel  
Acier inox brillant



**Pattumiere a pedale**  
**Pedal wastebin**  
**Poubelle à pédale**



**CRP12** 12L

Ø 25 x h40 cm, 2 kg

Gettacarta con coperchio e apertura a pedale in acciaio. Secchio interno estraibile in plastica.

*Lid with pedal opening steel wastebin.  
Inner plastic bucket.*

*Poubelle avec couvercle et ouverture à pédal.  
Seau intérieure en plastique.*

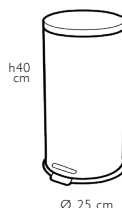

**CRP12 B**  
Acciaio verniciato bianco  
White metal painted  
Acier poudré blanc

**CRP12 A**  
Acciaio inox lucido  
Shiny stainless steel  
Acier inox brillant



**CRP5** 5L

Ø 23 x h28 cm, 1,3 kg

Gettacarta con coperchio e apertura a pedale in acciaio. Secchio interno estraibile in plastica.

*Lid with pedal opening steel wastebin.  
Inner plastic bucket.*

*Poubelle avec couvercle et ouverture à pédal.  
Seau intérieure en plastique.*



**CRP5 B**  
Acciaio verniciato bianco  
White metal painted  
Acier poudré blanc

**CRP5 A**  
Acciaio inox lucido  
Shiny stainless steel  
Acier inox brillant



**CRP3** 3L

Ø 16,7 x h27 cm, 1 kg

Gettacarta con coperchio e apertura a pedale in acciaio. Secchio interno estraibile in plastica.

*Lid with pedal opening steel wastebin.  
Inner plastic bucket.*

*Poubelle avec couvercle et ouverture à pédal.  
Seau intérieure en plastique.*



**CRP3 B**  
Acciaio verniciato bianco  
White metal painted  
Acier poudré blanc

**CRP3 A**  
Acciaio inox lucido  
Shiny stainless steel  
Acier inox brillant



# TALK



## **Soluzioni per la ristorazione “Made in Stil Casa”.**

Prodotti di massima qualità lavorati interamente all'interno dei nostri stabilimenti al momento dell'ordine, grazie all'utilizzo di innovativi macchinari e ad un'ampia possibilità di scelta tra le nostre proposte oppure personalizzabili secondo le vostre esigenze.

## **Restaurant's sector solutions “Made in Stil Casa”.**

High quality products completely manufactured inside our establishments, thanks to innovatives machines and a wide range of standard articles or customizable.

## **Solutions pour le secteur restaurant “Made in Stil Casa”.**

Produits de haute qualité fabriqué complètement dans nos entrepôts grace aux innovatives machines et à une grande proposition de articles standards ou personnalisables selon vos besoins.



MENU

# DOLLARO & SAFFIANO

Accessori e complementi di fattura artigianale e interamente italiana, realizzati in materiali tecnici che simulano pelle, legno e sughero, arricchiti da cuciture e icone metalliche. Il progetto è la sintesi perfetta del tailor made, venti colori e più di mille combinazioni.

Handcrafted and Italian made accessories and complements, realized in technical materials, which simulates leather, wood and cork, enriched from stitching and metal icons. The project is the perfect summary of the tailor made, twenty colors and hundred combinations possibilities.

Accessoires et compléments artisanales et Italiens, réalisées avec matériaux techniques qui simulent cuire, bois et liège ; enrichies des coutures et icônes métalliques. Le projet est la synthèse parfait du tailor made, vent couleurs et plus de mille combinassions.

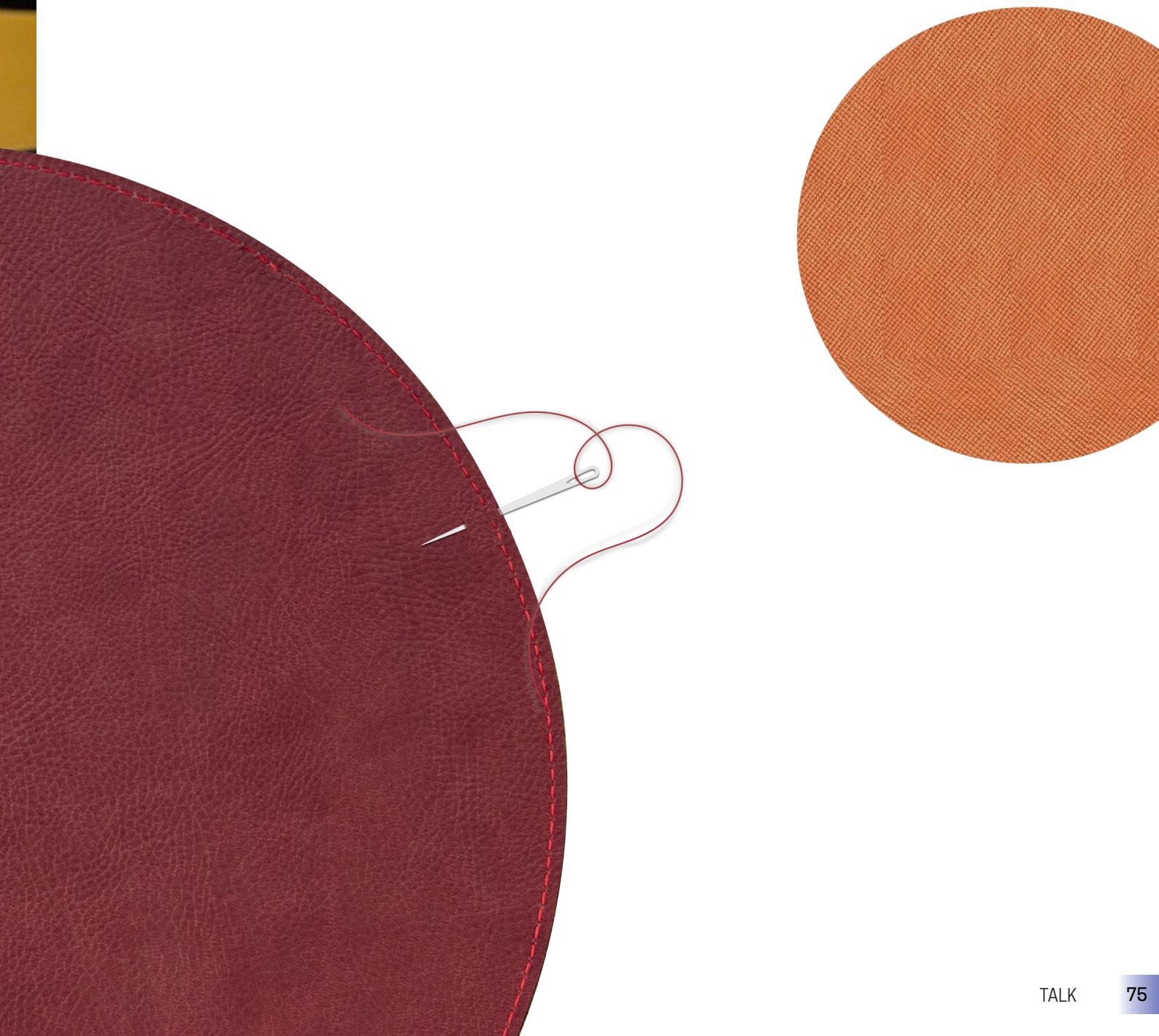

## COLORI

Colors  
Couleurs



## BI-COLOR

Bi-Colors  
Couleurs doubles





### **SOTTOPIATTO**

Sottopiatti e runner per la tavola in poluretano texturizzato accoppiato e rifinito con eleganti cuciture.

Molteplici varianti di colore e misure disponibili per soddisfare a pieno le vostre necessità.



### **PLACEMAT**

Runners and placemats for tables made of double polyurethane and finished with elegant sewings.

Multiple sizes and colors to fully satisfy your needs.

### **SET DE TABLE**

Set pour la table et runners en polyurethane doublé et couturé.

Plusieurs mesures et couleurs pour mieux répondre à tous vos besoins.





## FORMATI E CONFIGURAZIONE TAVOLI

Sizes and tables configurations  
Formats et configurations tables

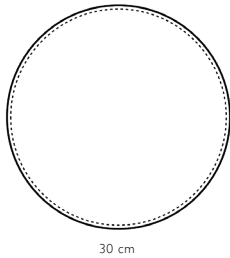

30 cm

**STP30D**

Ø 30 cm

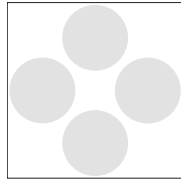

Configurazione tavolo 80x80 cm.  
Table configuration 80x80 cm.  
Configuration table de 80x80

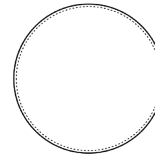

20 cm

**STP20D**

Ø 20 cm

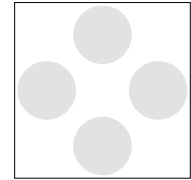

Configurazione tavolo 80x80 cm.  
Table configuration 80x80 cm.  
Configuration table de 80x80

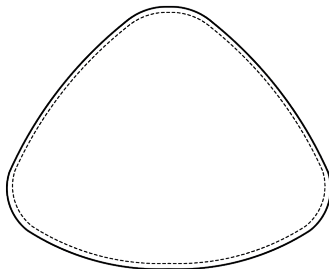

43 cm

**STP-LG**

43 x h35 cm

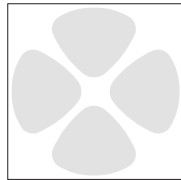

Configurazione tavolo 90x90 cm.  
Table configuration 90x90 cm.  
Configuration table de 90x90 cm.

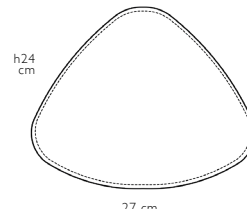

h24  
cm

27 cm

**STP-SG**

27 x h24 cm

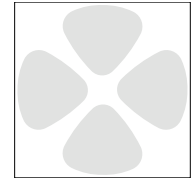

Configurazione tavolo 60x60 cm.  
Table configuration 60x60 cm.  
Configuration table de 60x60 cm.

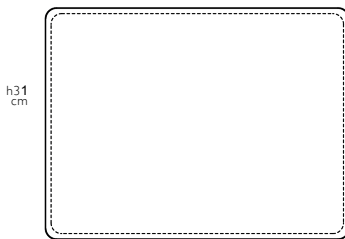

h31  
cm

41 cm

**TOV-D**

41 x h31 cm

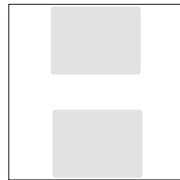

Configurazione tavolo 80x80 cm.  
Table configuration 80x80 cm.  
Configuration table de 80x80

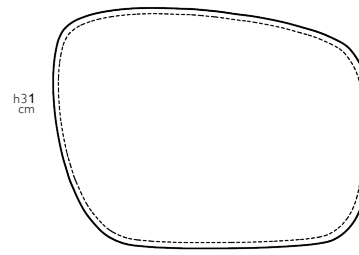

h31  
cm

41 cm

**TOV-OV-D**

41x h31 cm

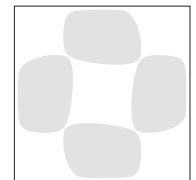

Configurazione tavolo 100x100 cm.  
Table configuration 100x100 cm.  
Configuration table de 100x100 cm.

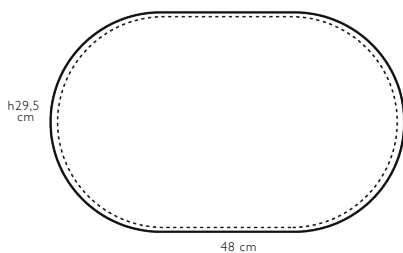

h29,5  
cm

48 cm

**TOV4830-D**

48x h29,5 cm

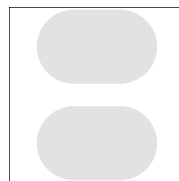

Configurazione tavolo 70x70 cm.  
Table configuration 70x70 cm.  
Configuration table de 70x70 cm.



## COLORI

Colors  
Couleurs



## BI-COLOR

Bi-Colors  
Couleurs doubles

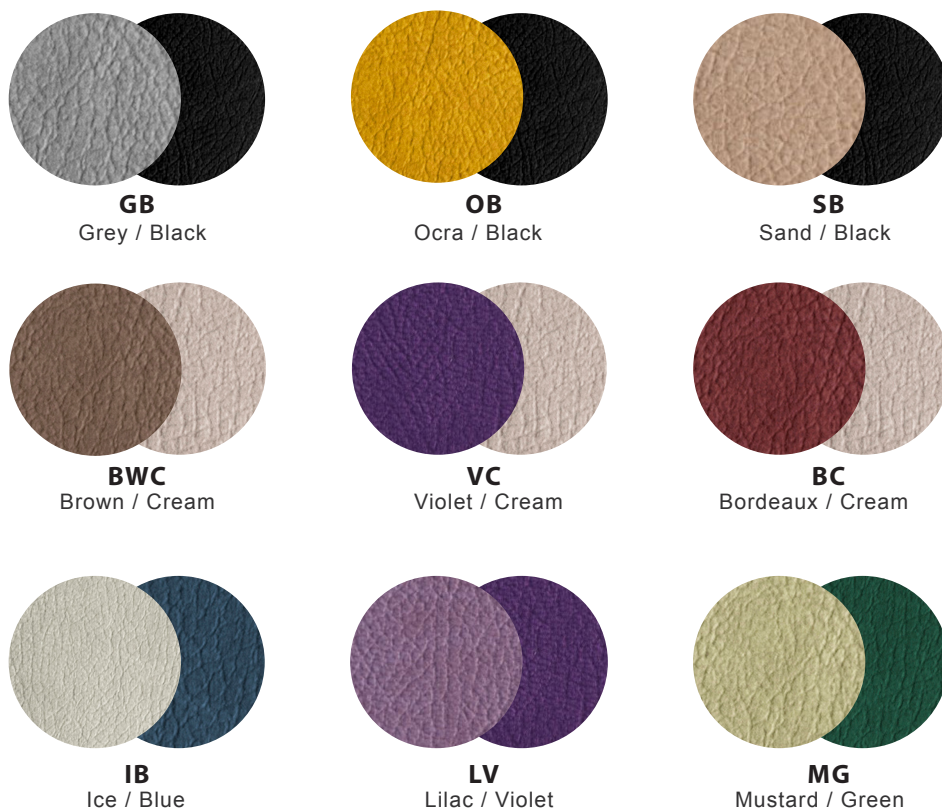





## FORMATI E CONFIGURAZIONE TAVOLI

Sizes and tables configurations

Formats et configurations tables

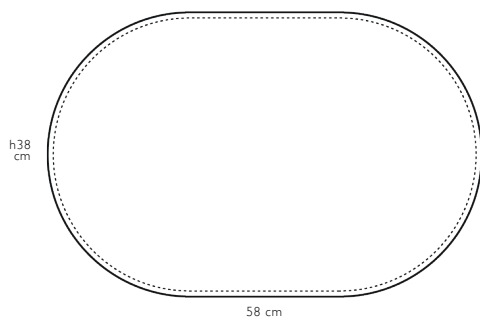

**RUN5838**  
58x h38 cm

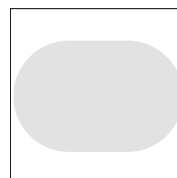

Configurazione tavolo 60x60 cm.  
Table configuration 60x60 cm.  
Configuration table de 60x60 cm.

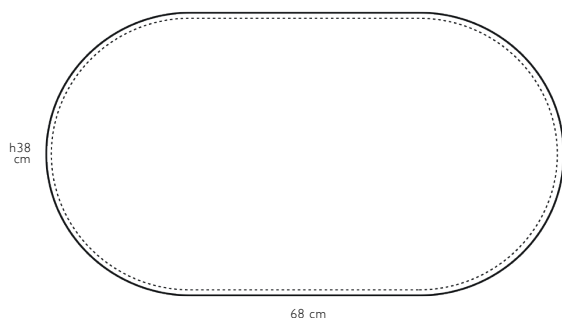

**RUN6838**  
68x h38 cm

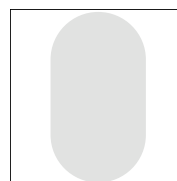

Configurazione tavolo 70x70 cm.  
Table configuration 70x70 cm.  
Configuration table de 70x70 cm.

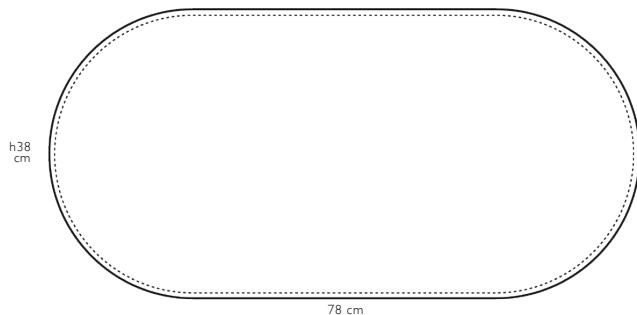

**RUN7838**  
78x h38 cm

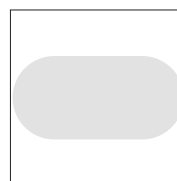

Configurazione tavolo 80x80 cm.  
Table configuration 80x80 cm.  
Configuration table de 80x80 cm.



## COLORI

Colors  
Couleurs



## BI-COLOR

Bi-Colors  
Couleurs doubles





### VASSOIO DA PORTATA

Vassoi in alluminio spessore 2 mm verniciati a polveri epossidiche colore nero micaceo.  
Interno in poliuretano texturizzato accoppiato e rifinito con eleganti cuciture.

### SERVICE TRAYS

Black micaceous color aluminum service tray, 2 mm thickness.  
Inner cover in double sewed polyurethane material.

### PLATEAUX DE SERVICE

Plateaux en aluminium poudré noir, épaisseur 2 mm.  
Couverture interne en polyuréthane doublé et couturé.



## FORMATI

Available sizes

Dimensions disponibles

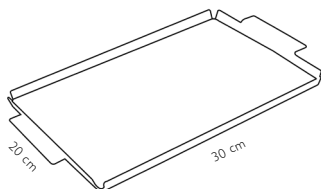

**VSN2030**  
20 x 30 cm

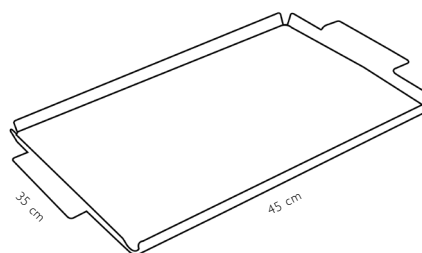

**VSN3545**  
35 x 45 cm

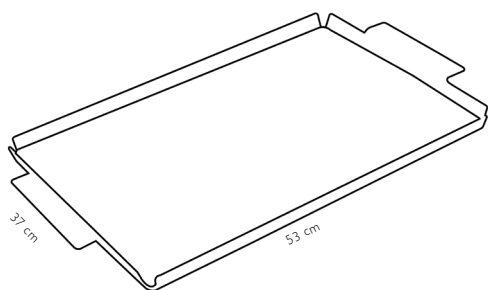

**VSN3753**  
37 x 53 cm

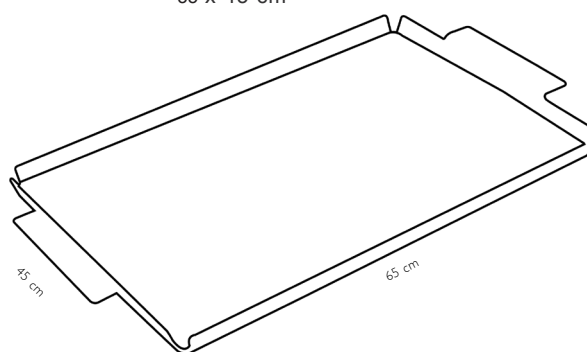

**VSN4565**  
45 x 65 cm

## COLORI

Colors

Couleurs

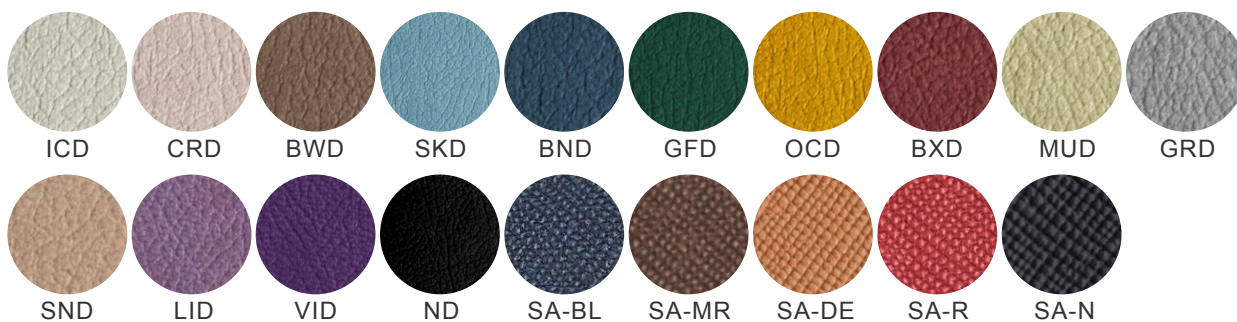

## BI-COLOR

Bi-Colors

Couleurs doubles



con sistema interno a fascia  
r with inner stripe system  
avec système intérieur à bande

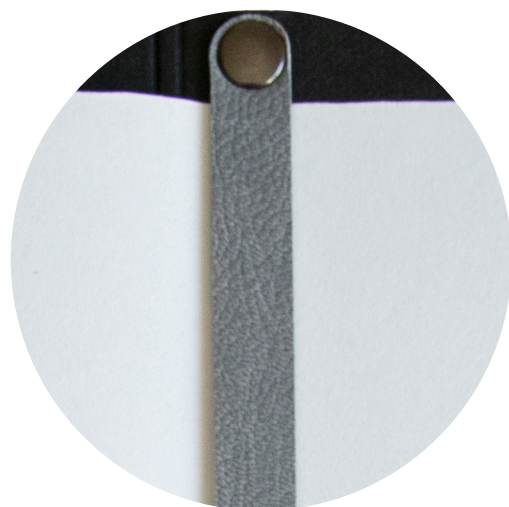

Pratico sistema di inserimento fogli di carta tramite fascia interna.

Inner practical stripe system which allows to insert paper sheets.

Pratic système intérieur à bande qui permet de insérer feuilles de papier.

**SISTEMA A FASCIA**  
Stripe system  
Système à bande



**Porta menu con sistema interno a fascia**  
**Menu holder with inner stripe system**  
**Porte menu avec système intérieur à bande**



## FORMATI

Menu sizes

Formats porte menus

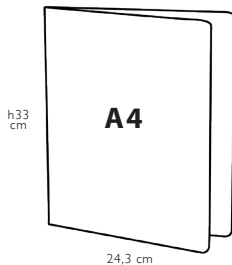

**PM2-F**  
24,3 x h33 cm

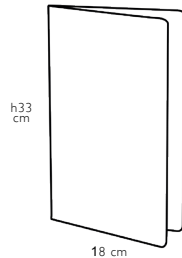

**PM22-F**  
18 x h33 cm

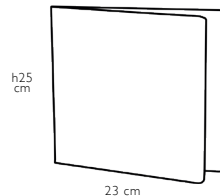

**PMQU-F**  
23 x h25 cm

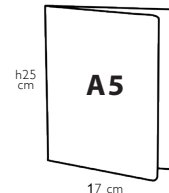

**PM3-F**  
17 x h25 cm

## COLORI

Colors

Couleurs



## TARGHETTE IN METALLO - 4x4 cm

Metal plaques - 4x4 cm

Plaques en métal porte menus - 4x4 cm



**MN-SI**



**WN-SI**



**MN-GR**



**WN-GR**



**MN-SN**



**WN-SN**



**MI-GR**

Targhetta incisa  
Engraved plaque  
Plaqué engravée



Porta menu con buste interne  
Menu holder with inner plastic sheets  
Porte menu avec enveloppes en plastique



Pratico sistema di inserimento fogli tramite 3 buste in plastica per un totale di 12 facciate, unite da corda elastica.

Inner practical elastic system with 3 plastic sheets for a total of 12 pages.

Pratic système intérieur avec 3 enveloppes en plastique, pour un total de 12 pages.



**SISTEMA CORDA**  
Elastic system  
Système avec élastique



**Porta menu con buste interne**  
**Menu holder with inner plastic sheets**  
**Porte menu avec enveloppes en plastique**



## FORMATI

Menu sizes

Formats porte menus

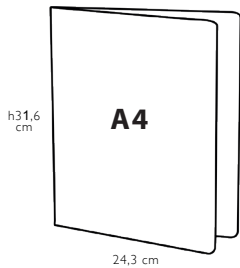

**PM2-C**  
24,3 x h31,6 cm

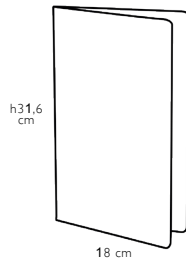

**PM22-C**  
18 x h31,6 cm

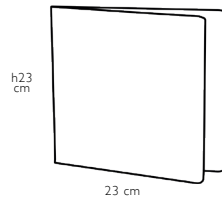

**PMQU-C**  
23 x h23 cm

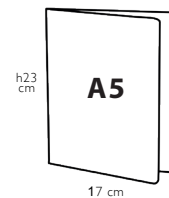

**PM3-C**  
17 x h23 cm

## COLORI

Colors

Couleurs



## TARGHETTE IN METALLO - 4x4 cm

Metal plaques - 4x4 cm

Plaques en métal porte menus - 4x4 cm



**MN-SI**



**WN-SI**



**MN-GR**



**WN-GR**



**MN-SN**



**WN-SN**



**MI-GR**

Targhetta incisa  
Engraved plaque  
Plaqué engravée





Porta menu con pinza fermafogli  
Paper holder clamp menu holder  
Menu avec pince support papier

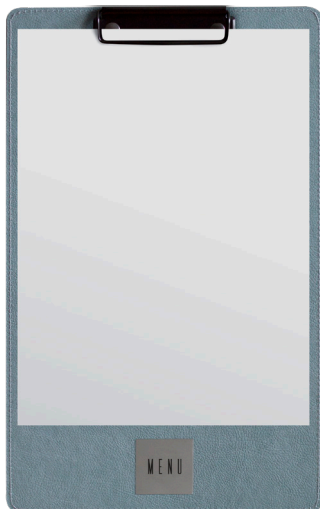
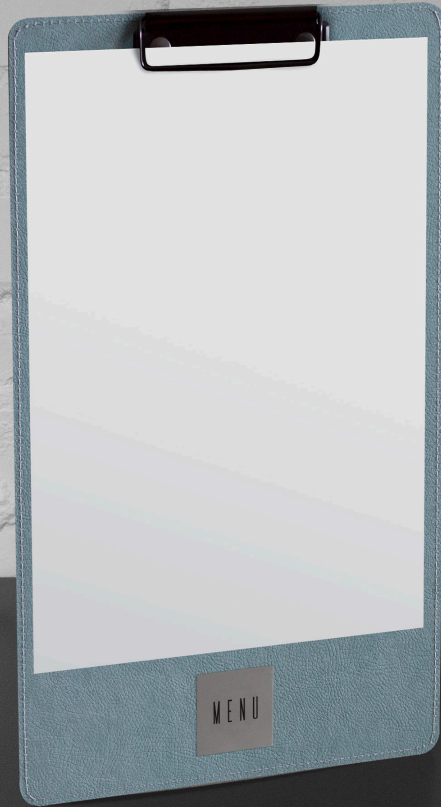

Pratico sistema di inserimento fogli tramite pinza in metallo verniciato nero, per sostituire facilmente il menù del giorno.

Inner practical black metal painted clamp system to easily replace the menu of the day.

Pratic système pour insérer les papiers du jour avec pince en métal poudré noir.

## SISTEMA PINZA

Clamp system

Système avec pince



Porta menu con pinza fermafogli  
Paper holder clamp menu holder  
Menu avec pince support papier



## FORMATI

Menu sizes

Formats porte menus

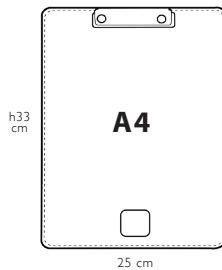

**PM2-PI**  
25 x h33 cm

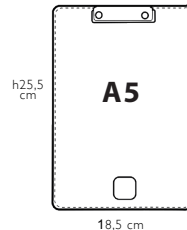

**PM3-PI**  
18,5 x h25,5 cm

## COLORI

Colors

Couleurs



## TARGHETTE IN METALLO - 4x4 cm

Metal plaques - 4x4 cm

Plaques en métal porte menus - 4x4 cm



Targhetta incisa  
Engraved plaque  
Plaque gravée



**PORTA POSATE**  
Cutlery holder  
Porte argenterie

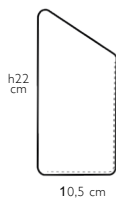

**PP**  
10,5 x h22 cm

**PORTA RESTO**  
Change holder  
Porte reste

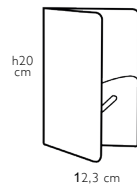

**PR**  
12,3 x h20 cm

**SOTTO BICCHIERE**  
Coaster  
Sous verre

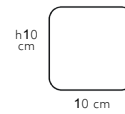

**STBQ**  
10 x h10 cm

## COLORI

Colors  
Couleurs

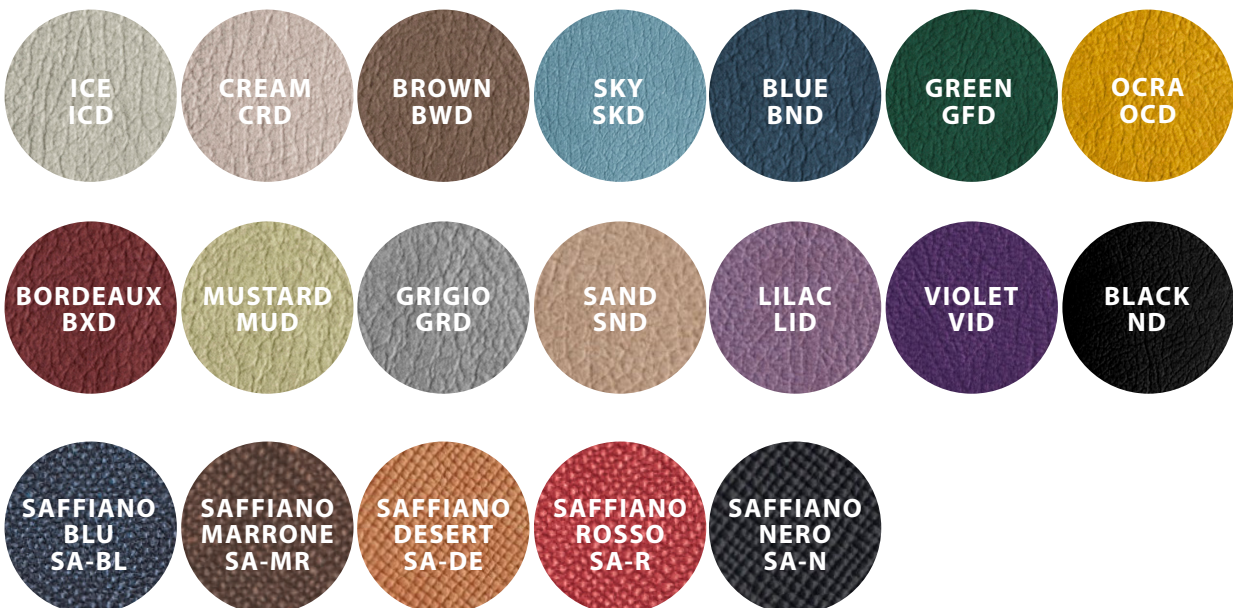



## BUSTE INTERNE

Inner sheets

Enveloppes internes

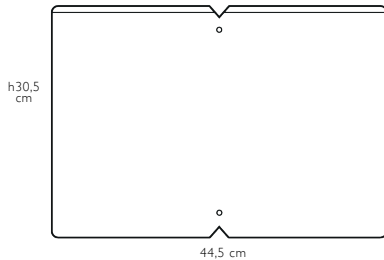

**BU-PM2**  
44,5 x h30,5 cm

Per codice PM2.  
Ogni busta è composta da 4 facciate.  
*For code PM2.  
Every sheet is composed of 4 faces.*  
*Pour code PM2.  
Les enveloppes sont composées de 4 faces.*

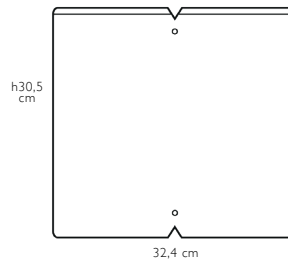

**BU-PM22**  
32,4 x h30,5 cm

Per codice PM22.  
Ogni busta è composta da 4 facciate.  
*For code PM22.  
Every sheet is composed of 4 faces.*  
*Pour code PM22.  
Les enveloppes sont composées de 4 faces.*

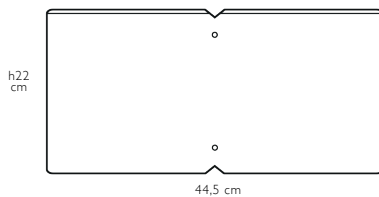

**BU-PMQU**  
44,5 x h22 cm

Per codice PMQU.  
Ogni busta è composta da 4 facciate.  
*For code PMQU.  
Every sheet is composed of 4 faces.*  
*Pour code PMQU.  
Les enveloppes sont composées de 4 faces.*

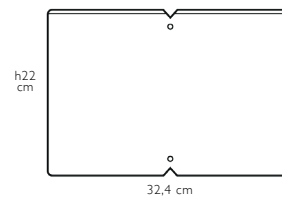

**BU-PM3**  
32,4 x h22 cm

Per codice PM3.  
Ogni busta è composta da 4 facciate.  
*For code PM3.  
Every sheet is composed of 4 faces.*  
*Pour code PM3.  
Les enveloppes sont composées de 4 faces.*

## ELASTICO

Elastic

Elastique



**EL-PM2F**  
h32 cm

Elastico interno di ricambio per menu  
formato codice PM2-F e PM22-F.  
*Inner elastic for menu holder code  
PM2-F and PM22-F.*  
*Elastique pour porte menu code PM2-F  
et PM22-F.*



**EL-PM3F**  
h23 cm

Elastico interno di ricambio per menu  
formato codice PMQU-F e PM3-F.  
*Inner elastic for menu holder code  
PMQU-F and PM3-F.*  
*Elastique pour porte menu code  
PMQU-F et PM3-F.*



Vassoi da camera  
Hotel room's trays  
Plateaux pour chambre de hotel



Vassoio in alluminio nero verniciato a polveri epossidiche, spessore 2 mm.  
Interno in poliuretano accoppiato.

Gamma di prodotti progettata per donare semplicità e praticità al servizio in camera.  
Vasta possibilità di combinazioni con l'articolo codice VKN-01 dotato di interno da un lato liscio e da un lato forato per agevolare l'inserimento dei vassoi.

Black metal painted tray, 2 mm thickness.  
Inner doubled and sewed polyurethane cover.

Product range projected to give simplicity and to help room services.  
Many combinations possibilities with article code VKN-01 as a base tray, which has one smooth side and one perforated side to easily put the other trays on.

Plateaux en aluminium noir, épaisseur 2 mm.  
Couverture interne en polyurethane doublé et couturé.

Une gamme de produits projetés pour aider le service des chambres.  
Plusieurs possibilités de combinaisons avec le code VKN-01 qui a une face lisse et une face perforée pour faciliter l'assemblage des plateaux.





## FORMATI

Trays sizes  
Dimensions

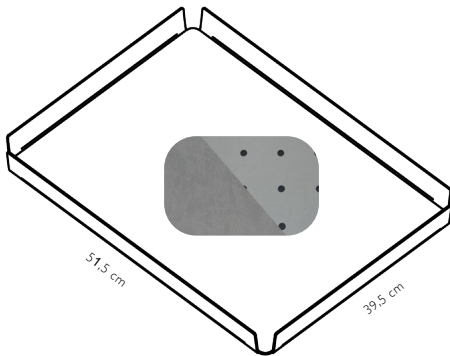

**VKN-01**

51,5 x 39,5 cm

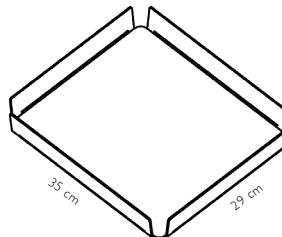

**VKN-02**

29 x 35 cm

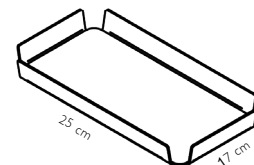

**VKN-03**

35 x 17 cm

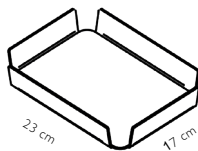

**VKN-04**

23 x 17 cm

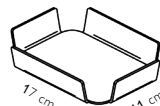

**VKN-05**

17 x 11 cm



**VKN-06**

11,5 x 11,5 cm

## COLORI

Colors  
Couleurs



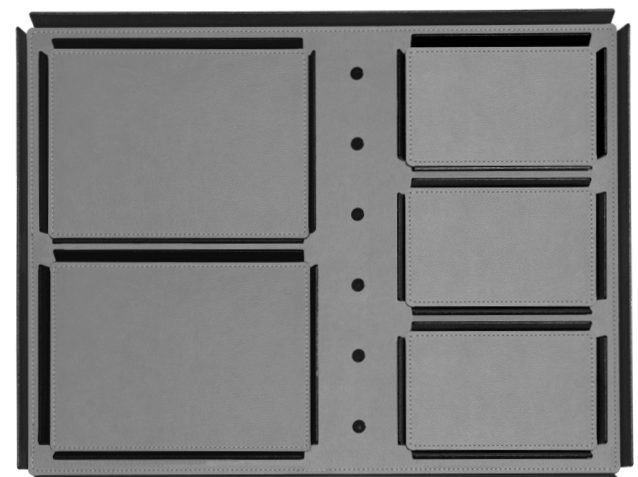
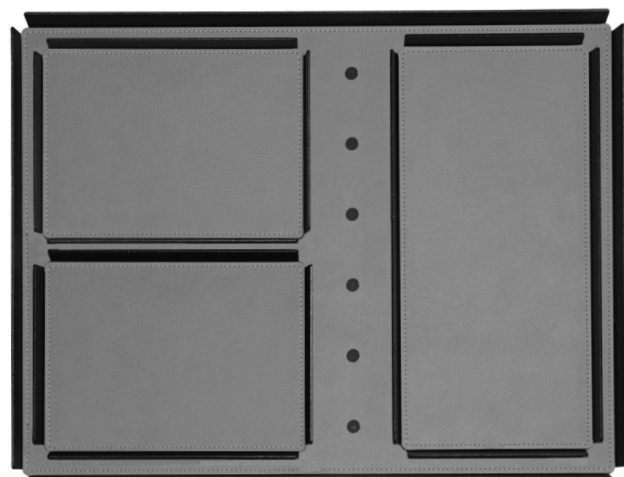
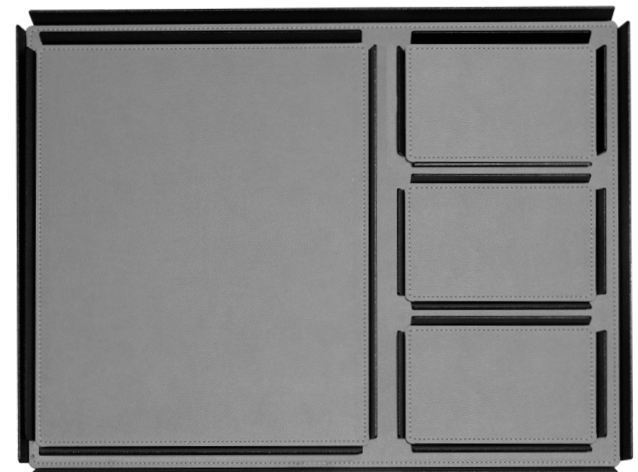
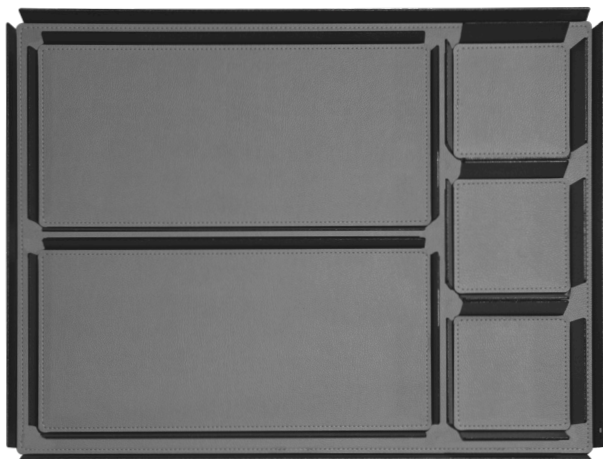
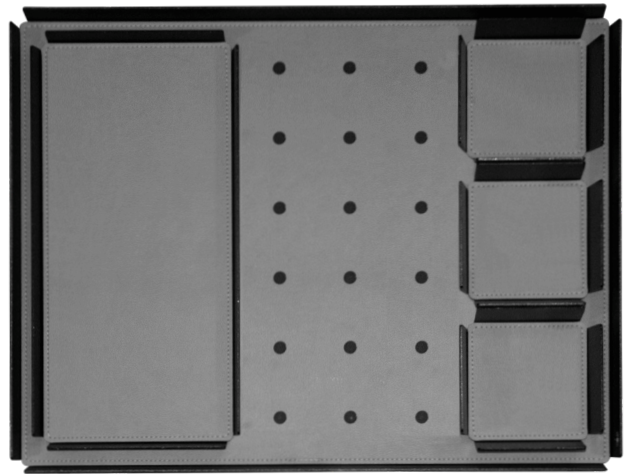
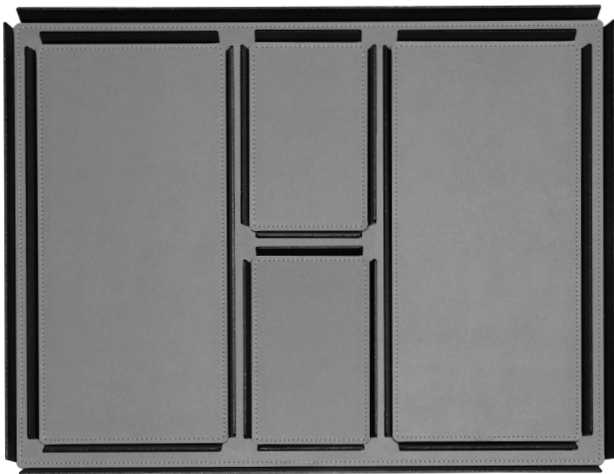



## COMBINAZIONI STANDARD - vassoio base VKN-01

Standard combinations - lower tray code VKN-01

Combinations standard - plateau base VKN-01

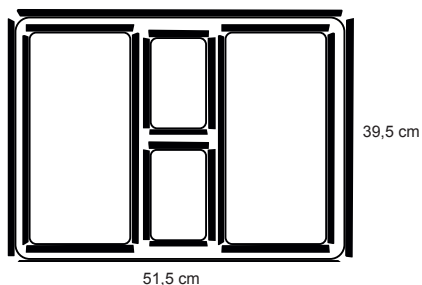

### VKN-3355

Combinazione: 2 x VKN-03 e 2 x VKN-05.  
Ideale per contenere tazze, bicchieri, bollitore, capsule caffè ecc.

*Combination of 2 x VKN-03 and 2 x VKN-05.  
Suitable to contain mugs, glasses, coffee capsule, exc.*

*Combination de 2 x VKN-03 et 2 x VKN-05. Adapte pour  
contener verres, tasses, capsules de café, exc.*

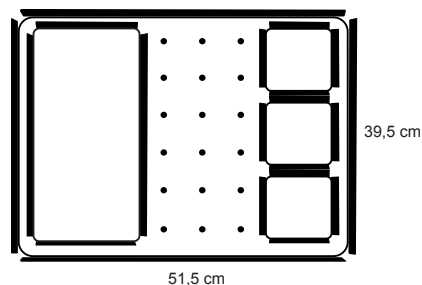

### VKN-3666

Combinazione 1 x VKN-03 e 3 x VKN-06.  
Ideale per contenere tazze, macchina del caffè, capsule caffè, bustine di zucchero, bustine tè ecc.

*Combination of 1 x VKN-03 and 3 x VKN-06.  
Suitable to contain coffee machine, coffee capsule,  
sugar packets, tea packets, exc.*

*Combination de 1 x VKN-03 et 3 x VKN-06. Adapte pour  
contener cafetière, tasses, capsules de café, paquets de  
sucre, sachets de thé exc.*

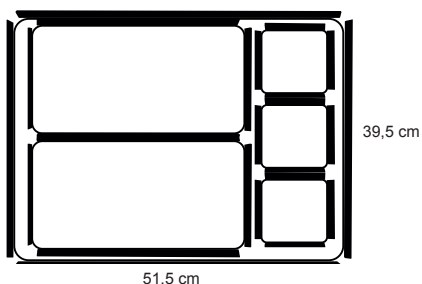

### VKN-33666

Combinazione 2 x VKN-03 e 3 x VKN-06.  
Ideale per contenere tazze, bicchieri, bollitore, capsule caffè, bustine di zucchero o tè, ecc.

*Combination of 2 x VKN-03 and 3 x VKN-06. Suitable to  
contain mugs, glasses, coffee capsule, sugar or tea pack-  
ets, exc.*

*Combination de 2 x VKN-03 et 3 x VKN-06. Adapte pour  
contener verres, tasses, capsules de café, sachets de thè  
ou de sucre, exc.*

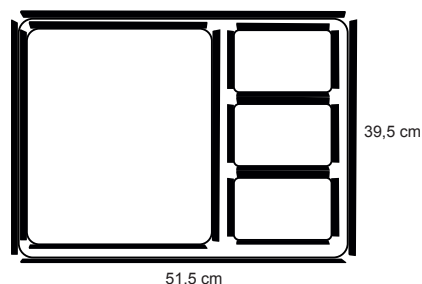

### VKN-2555

Combinazione 1 x VKN-02 e 3 x VKN-05.  
Ideale per contenere tazze, bicchieri, bollitore, capsule caffè ecc.

*Combination of 1 x VKN-02 and 3 x VKN-05.  
Suitable to contain mugs, glasses, coffee capsule, exc.*

*Combination de 1 x VKN-02 et 3 x VKN-05. Adapte pour  
contener verres, tasses, capsules de café, exc.*

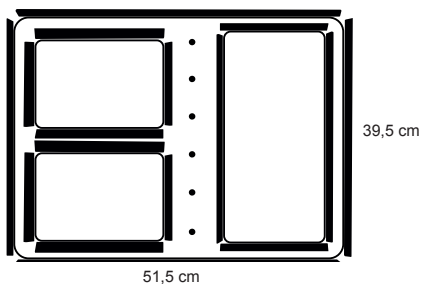

### VKN-344

Combinazione 1 x VKN-03 e 2 x VKN-04.  
Ideale per contenere tazze, bicchieri, bollitore, capsule caffè ecc.

*Combination of 1 x VKN-03 and 2 x VKN-04.  
Suitable to contain mugs, glasses, coffee capsule, exc.*

*Combination de 1 x VKN-03 et 2 x VKN-04. Adapte pour  
contener verres, tasses, capsules de café, exc.*

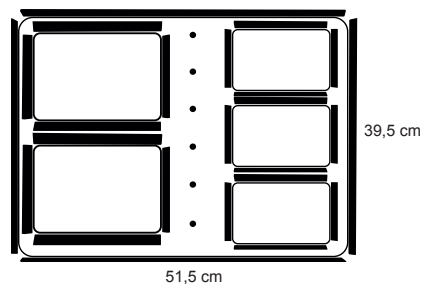

### VKN-44555

Combinazione 2 x VKN-04 e 3 x VKN-05.  
Ideale per contenere tazze, bicchieri, bollitore, capsule caffè ecc.

*Combination of 2 x VKN-04 and 3 x VKN-05.  
Suitable to contain mugs, glasses, coffee capsule, exc.*

*Combination de 2 x VKN-04 et 3 x VKN-05. Adapte pour  
contener verres, tasses, capsules de café, exc.*





**RACCOGLITORE CON GANCI**  
Portfolio with rings  
Reliure à anneaux

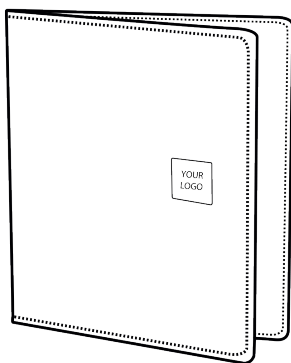

**G-RAC**  
31,5 x 25,6 cm



**RACCOGLITORE CON ELASTICO**  
Portfolio with elastic  
Reliure avec elastique

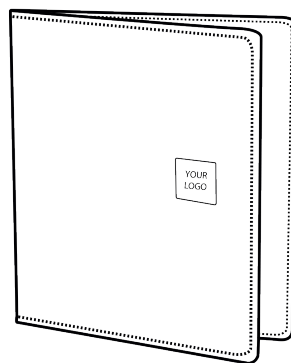

**E-RAC**  
31,5 x 24 cm



**SCRITTOIO**  
Writing pad  
Ecritoire

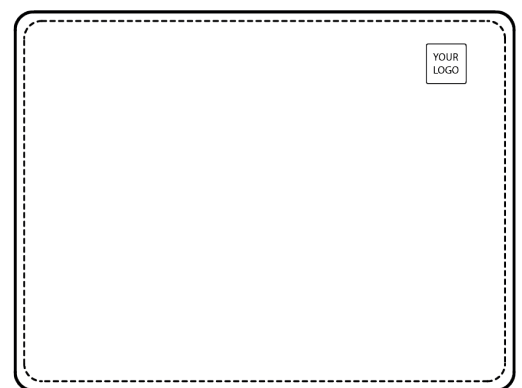

**SCR**  
45 X 34 cm



**PORTA TESSERA**

Card holder  
Porte carte d'hotel

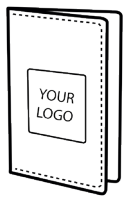

**CH**

6,5 x 10,5 cm

**PORTA CHIAVI**

Key Holder  
Porte-clés



**PK**

6 x 12 cm

**CARTELLO PORTA**

Door hanger  
Panneau pour porte

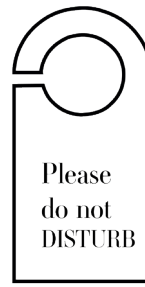

**AND-PND**

10 x 20 cm

**CARTELLO PORTA**

Door hanger  
Panneau pour porte

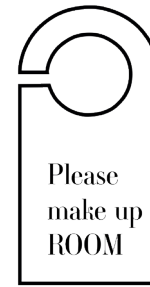

**AND-MKR**

10 x 20 cm

**TARGA IN METALLO - 4x4 cm**

Metal plaques - 4x4 cm  
Plaques en métal porte menus - 4x4 cm



VEDI PAGINA 103  
See page 103  
Voir page 103

**COLORI**

Colors  
Couleurs





Porta menu con buste interne  
Menu holder with inner plastic sheets  
Porte menu avec enveloppes en plastique



# LINEA PELLE

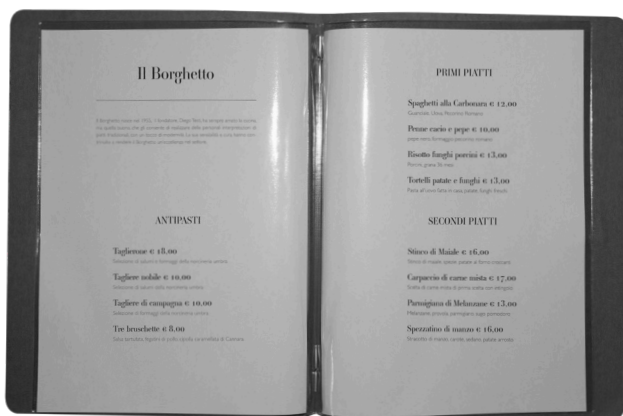

Pratico sistema di inserimento fogli tramite 3 buste in plastica per un totale di 12 facciate, unite da clips metalliche.

Inner practical metal clips system with 3 plastic sheets for a total of 12 pages.

Pratic système intérieur avec 3 enveloppes en plastique fermées par deux clips, pour un total de 12 pages.

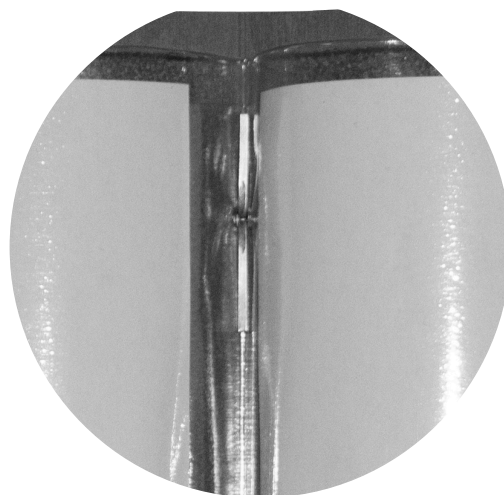

## SISTEMA CLIP

Clips system

Système avec clips



**Porta menu con buste interne**  
**Menu holder with inner plastic sheets**  
**Porte menu avec enveloppes en plastique**



## FORMATI

Menu sizes

Formats porte menus

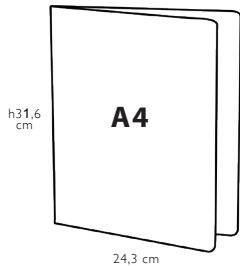

**PM2**  
24,3 x h31,6 cm

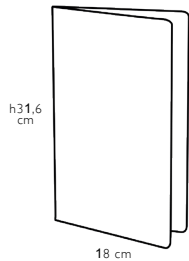

**PM22**  
18 x h31,6 cm

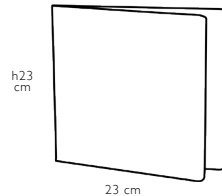

**PMQU**  
23 x h23 cm

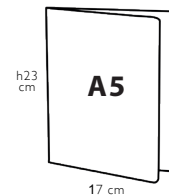

**PM3**  
17 x h23 cm

## COLORI

Colors

Couleurs

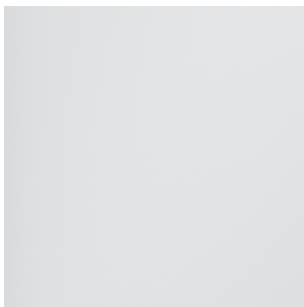

**BI**  
BIANCO  
White / Blanc

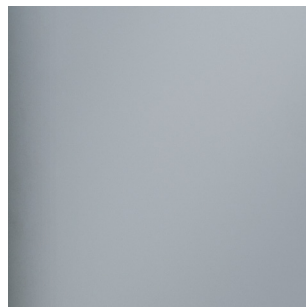

**G**  
GRIGIO  
Grey / Gris



**N**  
NERO  
Black / Noir

## TARGHE IN METALLO - 4x4 cm

Metal plaques - 4x4 cm

Plaques en métal porte menus - 4x4 cm



**MN-SI**



**WN-SI**



**MN-GR**



**MN-GR**



**MN-SN**



**WN-SN**



**MI-GR**

Targhetta incisa  
Engraved plaque  
Plaque gravée



Ricambi  
Spare parts  
Replacements



### PORTA RESTO

Change holder  
Porte reste

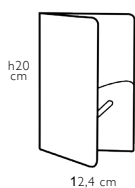

**PR**

12,4 x h20 cm

### SOTTO PIATTO

Placemat  
Set de table

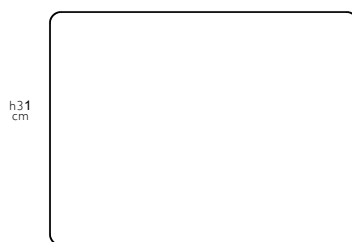

**TOV**

41 x h31 cm

### SOTTO BICCHIERE

Coaster  
Sous verre

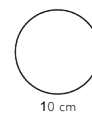

**STB**

Ø 10 cm

### COLORI

Colors  
Couleurs

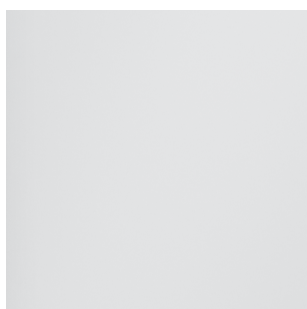

**BI**

BIANCO  
White / Blanc

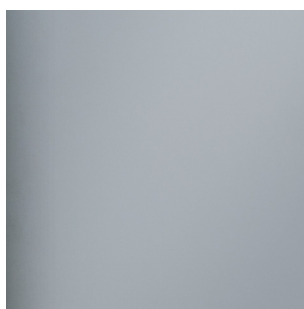

**G**

GRIGIO  
Grey / Gris

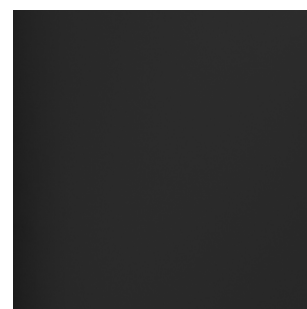

**N**

NERO  
Black / Noir



## BUSTE INTERNE

Inner sheets

Enveloppes internes

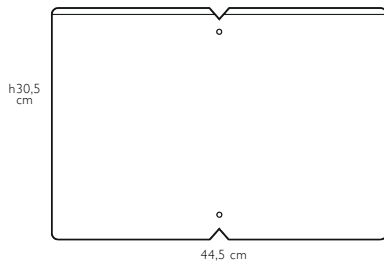

**BU-PM2**  
44,5 x h30,5 cm

Per codice PM2.  
Ogni busta è composta da 4 facciate.  
*For code PM2.  
Every sheet is composed of 4 faces.*  
*Pour code PM2.  
Les enveloppes sont composées de 4 faces.*

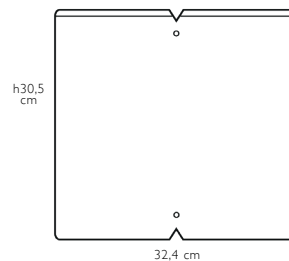

**BU-PM22**  
32,4 x h30,5 cm

Per codice PM22.  
Ogni busta è composta da 4 facciate.  
*For code PM22.  
Every sheet is composed of 4 faces.*  
*Pour code PM22.  
Les enveloppes sont composées de 4 faces.*

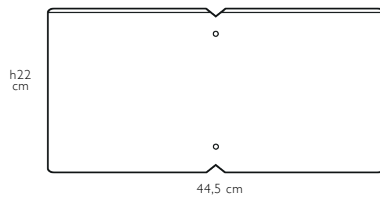

**BU-PMQU**  
44,5 x h22 cm

Per codice PMQU.  
Ogni busta è composta da 4 facciate.  
*For code PMQU.  
Every sheet is composed of 4 faces.*  
*Pour code PMQU.  
Les enveloppes sont composées de 4 faces.*

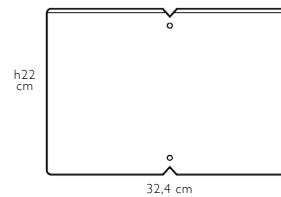

**BU-PM3**  
32,4 x h22 cm

Per codice PM3.  
Ogni busta è composta da 4 facciate.  
*For code PM3.  
Every sheet is composed of 4 faces.*  
*Pour code PM3.  
Les enveloppes sont composées de 4 faces.*

## CLIP FERMA FOGLI

Metal clips

Clips en métal



### CLIP

Confezione da 100 pezzi.  
*Pack of 100 pieces.*  
*Sachet de 100 pièces.*



## PERSONALIZZAZIONE

Puoi personalizzare le linee proposte con il tuo logo in modo semplice e veloce. Invia il logo desiderato a [stilcasa@stil-casa.it](mailto:stilcasa@stil-casa.it) in formato vettoriale (PDF - AI).

N.B. I colori delle bozze, osservati a monitor e/o realizzati con stampanti a getto d'inchiostro / laser, sono puramente indicativi, le conseguenti differenze di cromacità non potranno essere pertanto considerate come imperfezione o difetto del manufatto.

Verranno comunque prese tutte le precauzioni necessarie per ottenere il risultato ottimale.

Per maggiori informazioni contattaci: +39 0375 790114

---

## CUSTOMIZATION

You can customise the proposed lines quickly and easily. Send your logo to [stilcasa@stil-casa.it](mailto:stilcasa@stil-casa.it) in vectorial format (PDF - AI).

Important: Drafts colours, watched on screens or printed with ink or laser printer are only indicatives, and possibly differences between the physical item must not be considered as imperfections or lacks. All cautions will be taken to obtain the optimal result.

For more information: +39 0375 790114

---

## PERSONNALISATION

Vous pouvez personnaliser les lignes proposées avec votre logo simplement et rapidement. Envoyez le logo à [stilcasa@stil-casa.it](mailto:stilcasa@stil-casa.it) en format vectorial (PDF - AI).

Important: les couleur des bons à tirer, observés sur l'ordinateur ou imprimés avec imprimante à jet d'encre ou laser son seulement indicatives, les possibles différences de coculeurs ne seront pas considérée comme erreurs ou défauts. Tous les mesurers pour une bonne résultat seron prises.

Pour plusieurs d'informations vous pouvez nous contacter au: + 39 0375 790114

## LE NOSTRE PROPOSTE - TARGHE STAMPATE - min. 24 pz

Our printed plaques proposal - minimum 24 pcs

Nos propositions de plaques imprimée - minimum 24 pcs



GPN-SB



GVN-SB



GPN-SO



GVN-SO



GPN-RG



GVN-RG

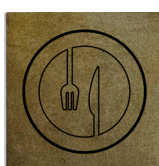

GPN-GL



GVN-GL

## LE NOSTRE PROPOSTE - TARGHE INCISE (non personalizzabili) - min. 24 pz

Our engraved plaques proposal (not customizable) - minimum 24 pcs

Nos propositions de plaques gravées (pas personnalisables) - minimum 24 pcs



MI-SB



MI-SO



MI-SN

## PERSONALIZZAZIONI SU TARGHE - min. 24 pz

Customized plaques with your graphics - minimum 24 pcs

Plaques personnalisés avec vos graphiques - minimum 24 pcs



T-PERS-SN



T-PERS-SB

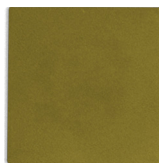

T-PERS-SO



T-PERS-RG

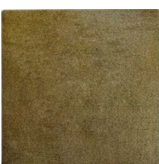

T-PERS-GL



T-PERS-SI



T-PERS-GR





## Personalizzazioni con stampa digitale a inchiostro UV-Led diretta sul materiale.

Your graphics directly printed directly on the materials with a UV-Led digital printer  
 Impression digitale de vos graphiques directe sur le matériel avec UV-Led imprimante

### SELEZIONE VASSOI DA SERVIZIO E HOTEL

Service and hotel trays line

Ligne plateaux de servie et pour hotel

<b>Codice</b> <i>Code</i> <i>Code</i>	<b>Dimensioni</b> <i>Size</i> <i>Dimensions</i>	<b>Minimo ordine</b> <i>Order minimum</i> <i>Minimum commande</i>	<b>Pagina catalogo</b> <i>Catalog page</i> <i>Page catalogue</i>
<b>VSC2030</b>	20 x 30 cm	<b>19</b>	83
<b>VSN3545</b>	35 x 45 cm	<b>12</b>	83
<b>VSN3753</b>	37 x 53 cm	<b>12</b>	83
<b>VSN4565</b>	45 x 65 cm	<b>12</b>	83
<b>VKN01</b>	51,5 x 39,5 cm	<b>10</b>	92-93
<b>VKN02</b>	29 x 35 cm	<b>22</b>	92-93
<b>VKN03</b>	35 x 17 cm	<b>17</b>	92-93
<b>VKN04</b>	23 x 17 cm	<b>28</b>	92-93
<b>VKN05</b>	17 x 11 cm	<b>55</b>	92-93
<b>VKN06</b>	11,5 x 11,5 cm	<b>44</b>	92-93

## SELEZIONE DOLLARO E SAFFIANO

Dollaro and Saffiano line

Ligne Dollaro et Saffiano

<b>Codice</b> <i>Code</i> <i>Code</i>	<b>Dimensioni</b> <i>Size</i> <i>Dimensions</i>	<b>Minimo ordine</b> <i>Order minimum</i> <i>Minimum commande</i>	<b>Pagina catalogo</b> <i>Catalog page</i> <i>Page catalogue</i>
<b>PM2-F</b>	24,3 x h33 cm	<b>48</b>	84-85
<b>PM3-F</b>	17 x h25 cm	<b>56</b>	84-85
<b>PM22-F</b>	18 x h33 cm	<b>40</b>	84-85
<b>PMQU-F</b>	23 x h25 cm	<b>40</b>	84-85
<b>PM2-C</b>	24,3 x h31,6 cm	<b>48</b>	86-87
<b>PM3-C</b>	17 x h23 cm	<b>56</b>	86-87
<b>PM22-C</b>	18 x h31,6 cm	<b>40</b>	86-87
<b>PMQU-C</b>	23 x h23 cm	<b>40</b>	86-87
<b>PR</b>	12,3 x h20 cm	<b>64</b>	90
<b>PP</b>	10,5 x h22 cm	<b>56</b>	90
<b>STBQ</b>	10 x h10 cm	<b>117</b>	90
<b>STP30D</b>	30 cm	<b>60</b>	78-79
<b>STP20D</b>	20 cm	<b>68</b>	78-79
<b>STP-LG</b>	43 x h35 cm	<b>60</b>	78-79
<b>STP-SG</b>	27 x h24 cm	<b>60</b>	78-79
<b>TOV-D</b>	41 x h31 cm	<b>45</b>	78-79
<b>TOV-OV-D</b>	41 x h31 cm	<b>45</b>	78-79
<b>TOV4830-D</b>	48 x h30 cm	<b>45</b>	78-79
<b>RUN5838</b>	58 x h38 cm	<b>30</b>	80-81
<b>RUN6838</b>	68 x h38 cm	<b>32</b>	80-81
<b>RUN7838</b>	78 x h38 cm	<b>30</b>	80-81

## SELEZIONE PELLE RIGENERATA

Regenerated leather line

Ligne Peau régénéré

<b>PM2</b>	24,3 x h31,6 cm	<b>64</b>	99
<b>PM3</b>	17 x h23 cm	<b>48</b>	99
<b>PM22</b>	18 x h31,6 cm	<b>64</b>	99
<b>PMQU</b>	23 x h23 cm	<b>72</b>	99
<b>PR</b>	12,3 x h20 cm	<b>54</b>	100
<b>TOV</b>	41 x h31 cm	<b>32</b>	100
<b>STB</b>	10 x h10 cm	<b>224</b>	100

in materiale composito satinato  
 composit material pictograms  
 es en matériel composé brossé



**PR1-U**  
16 x 16 cm



**PR2-D**  
16 x 16 cm



**PR3-UD**  
16 x 16 cm



**PR4-K**  
16 x 16 cm



**PR5-F**  
16 x 16 cm



**PR6-D**  
16 x 16 cm



**PR7-I**  
16 x 16 cm



**PR8-G**  
16 x 16 cm



**PR9-D**  
16 x 16 cm



**PR10-W**  
16 x 16 cm



**PR11-A**  
16 x 16 cm



**PR12-F**  
16 x 16 cm



**PR13-I**  
16 x 16 cm



**PR14-FU**  
16 x 16 cm



**PR15-DFU**  
16 x 16 cm



**PR16-T**  
16 x 16 cm



**PR17-TS**  
16 x 16 cm



**PR18-R**  
16 x 16 cm



**PR19-BA**  
16 x 16 cm



**PR20-BA2**  
16 x 16 cm



**PR21-CO**  
16 x 16 cm



**PR22-IP**  
16 x 16 cm



**PR23-WF**  
16 x 16 cm



**PR24-CU**  
32,5 x 16 cm



**PR25-UF**  
32,5 x 16 cm



**PR26-PR**  
32,5 x 16 cm



**Pittogrammi in PVC 3 mm - fissaggio con biadesivo**  
**PVC 3 mm pictograms - double tape fixing**  
**Pictogrammes en PVC 3 mm - fixation avec adhésif**



**PU1-U-AS**  
16 x 16 cm



**PU2-D-AS**  
16 x 16 cm



**PU3-UD-AS**  
16 x 16 cm



**PU4-K-AS**  
16 x 16 cm



**PU5-D-AS**  
16 x 16 cm

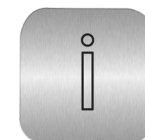

**PU6-I-AS**  
16 x 16 cm



**PU7-G-AS**  
16 x 16 cm



**PU8-D-AS**  
16 x 16 cm



**PU9-W-AS**  
16 x 16 cm



**PU10-A-AS**  
16 x 16 cm

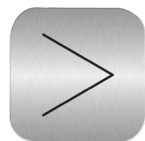

**PU11-F-AS**  
16 x 16 cm



**PU12-FS-AS**  
16 x 16 cm



**PU13-I-AS**  
16 x 16 cm



**PU14-DFU-AS**  
16 x 16 cm



**PU15-R-AS**  
16 x 16 cm



**PU16-BA-AS**  
16 x 16 cm



**PU17-BA2-AS**  
16 x 16 cm



**PU18-WF1-AS**  
16 x 16 cm



**PU19-WF2-AS**  
16 x 16 cm



**PU20-SL-AS**  
16 x 16 cm



**PU21-SA-AS**  
16 x 16 cm



**PU22-PI-AS**  
16 x 16 cm



**PU23-PA-AS**  
16 x 16 cm



**PU24-FR-AS**  
16 x 16 cm



**PU25-CU-AS**  
16 x 16 cm



## HOTEL

Una linea di prodotti essenziali e funzionali per la fornitura alberghiera, che permette a tutte le strutture ricettive di soddisfare le proprie esigenze di accoglienza clienti.

**Creare un'atmosfera ordinata e rilassante è l'obiettivo del settore hotellerie.**

## HOTEL

An essential and functional line for hotels furnitures, which allows all the accommodations to satisfy their needs in the hospitality's setting.

**To create an ordered and relaxing atmosphere is the hotels sector's aim.**

## HOTEL

Ligne de produits fonctionnelle et essentielle dédiée aux fournitures pour hôtels, qui permet à tous les structures de satisfaire leur nécessités pour l'accueil des clients.

**Créer une atmosphère ordonnée et reposant est le but du secteur hôtellerie.**



## 600

Ø 32 x Ø 7 x h104 cm, 9 kg

Colonna dividi folla in acciaio verniciato con nastro rosso, blu o nero lunghezza massima 250 cm.

*Painted steel crowd control barrier with 250 cm red, blue or black tape.*

*Poteau de guidage en acier peint avec bande rouge, bleu ou noire de 250 cm.*



### 600N-01

Acciaio nero - nastro rosso  
Black steel - red tape  
Acier noir - bande rouge



### 600G-01

Acciaio grigio - nastro rosso  
Gray steel - red tape  
Acier gris - bande rouge



### 600N-02

Acciaio nero - nastro blu  
Black steel - blue tape  
Acier noir - bande bleu



### 600G-02

Acciaio grigio - nastro blu  
Gray steel - blue tape  
Acier gris - bande bleu



### 600N-03

Acciaio nero - nastro nero  
Black steel - black tape  
Acier noir - bande noire



### 600G-03

Acciaio grigio - nastro nero  
Gray steel - black tape  
Acier gris - bande noire



## 605 V

21 x h30 cm, 1 kg

Display per fogli formato A4, struttura in acciaio verniciato nero e copertura interna in plexiglass.

*Black painted steel display suitable for A4 sheets, plexiglass inner cover.*

*Display en acier peint noir pour papier format A4, couverture interne en plexiglass.*



## 605 O

30 x h21 cm, 1 kg

Display per fogli formato A4, struttura in acciaio verniciato nero e copertura interna in plexiglass.

*Black painted steel display suitable for A4 sheets, plexiglass inner cover.*

*Display en acier peint noir pour papier format A4, couverture interne en plexiglass.*

**schettoni e leggii  
stands and column with stand  
isquetons et poteaux à pupitre**

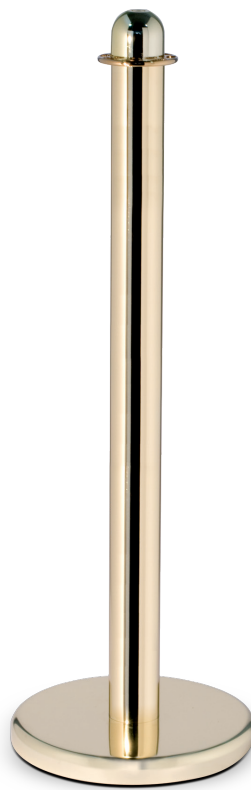
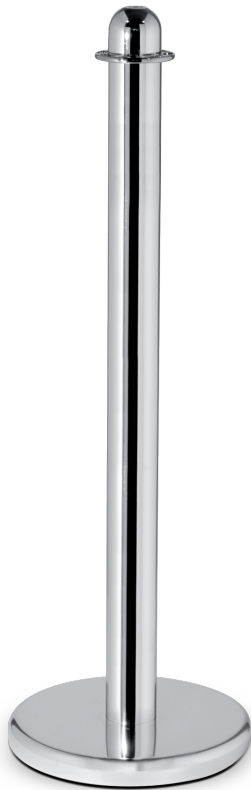

**606**

Ø 32 x Ø 7 x h106 cm, 11 kg

Colonna in acciaio inox con predisposizione al montaggio display oppure con cordone dividi folla.  
*Stainless steel barrier with display mounting predisposition or crowd control rope.*  
*Poteau en acier inox avec prédisposition pour montage display ou corde pour séparer la queue.*

**606 A**  
Acciaio inox lucido  
Stainless steel  
Acier inox brillant

**606 OT**  
Acciaio inox ottonato  
Brassed stainless steel  
Acier inox laitoné



**618**

28 x h34 cm, 1,5 kg

Display per fogli formato A4, struttura in acciaio inox e copertura interna in plexiglass.  
*Stainless steel display suitable for A4 sheets, plexiglass inner cover.*  
*Display en acier inox pour papier format A4, couverture interne en plexiglass.*

**618 A**  
Acciaio inox lucido  
Stainless steel  
Acier inox brillant

**618 OT**  
Acciaio inox ottonato  
Brassed stainless steel  
Acier inox laitoné



**619**

49 x h34 cm, 2 kg

Display per fogli formato A3, struttura in acciaio inox e copertura interna in plexiglass.  
*Stainless steel display suitable for A3 sheets, plexiglass inner cover.*  
*Display en acier inox pour papier format A3, couverture interne en plexiglass.*

**619 A**  
Acciaio inox lucido  
Stainless steel  
Acier inox brillant

**619 OT**  
Acciaio inox ottonato  
Brassed stainless steel  
Acier inox laitoné



**Colonne con cordone e display**  
**Crowd control barrier and display**  
**Poteaux de guidage et display**



**607**

Ø 3 cm

Fune ritorta in polipropilene ad alta tenacità, per colonne dividi folla.

Taglio su misura. Consigliato massimo 2,20 mt.

*High teacity polypropylene twisted rope. Custom cutting. Maximum length recommended 2,20 mt.*

*Corde torsadée en polypropylène haute ténacité pour poteaux de guidage. Coupe personnalisée. Recommandé maximum 2,20 mètres.*

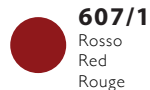

**607/1**

Rosso  
Red  
Rouge

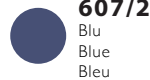

**607/2**

Blu  
Blue  
Bleu



**607/4**

Canapa  
Hemp color  
Couleur chènevis



**607/5**

Marrone  
Brown  
Marron

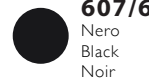

**607/6**

Nero  
Black  
Noir



**607/7**

Verde  
Green  
Vert



**608**

Ø 3,5 x h10,5 cm, 0,2 kg

Moschettone in acciaio inox, fissaggio alla corda effettuato presso i nostri magazzini.

*Stainless steel hook, rope fixing directly made in our warehouse.*

*Mousqueton en acier inox, fixation à la corde réalisée dans nos entrepôts.*



**608 A**

Acciaio inox  
Stainless steel  
Acier inox brillant

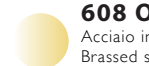

**608 OT**

Acciaio inox ottonato  
Brassed stainless steel  
Acier inox laitoné



**622**

Ø 32 x Ø 7 x h140 cm, 12 kg

Leggio con colonna in acciaio inox e supporto in plexiglass bronzato.

*Stainless steel column stand with bronzed plexiglass support.*

*Poteau en acier inox avec pupitre en plexiglass bronzé.*



**622 A**

Accio inox lucido  
Stainless steel  
Acier inox brillant



**622 OT**

Acciaio inox ottonato  
Brassed stainless steel  
Acier inox laitoné



